



PRACTICAL GUIDE FOR

Improving Resource Efficiency in Red Meat Abattoirs in South Africa

IN PARTNERSHIP WITH



Creating Markets, Creating Opportunities

About IFC

IFC – a member of the World Bank Group – is the largest global development institution focused on the private sector in emerging markets. We work in more than 100 countries, using our capital, expertise, and influence to create markets and opportunities in developing countries. In fiscal year 2020, we invested \$22 billion in private companies and financial institutions in developing countries, leveraging the power of the private sector to end extreme poverty and boost shared prosperity. For more information, visit www.ifc.org.

© International Finance Corporation [2020]. All rights reserved.

2121 Pennsylvania Avenue, N.W.
Washington, D.C. 20433
Internet: www.ifc.org

The material in this work is copyrighted. Copying and/or transmitting portions or all of this work without permission may be a violation of applicable law. IFC does not guarantee the accuracy, reliability or completeness of the content included in this work, nor the conclusions or judgments described herein, and accepts no responsibility or liability for any omissions or errors (including, without limitation, typographical errors and technical errors) in the content whatsoever, or for reliance thereon.

Cover Image: ©depositphotos_dfuentesphotostock

Contents

1. Executive Summary	5
2. Background	11
3. Monitoring Systems	13
Implement an Effective Metering and Monitoring System	13
4. Water	15
Water Supply	17
Water Usage	18
Summary of Water Efficiency Recommendations	25
5. Energy	27
Electrical Energy	28
Thermal Energy	39
Summary of Energy Efficiency Recommendations	49
6. Summary and Conclusions	51
References	52

Figures

Figure 1: Recommended metering programme	13
Figure 2: Water availability per person per year in selected countries	15
Figure 3: Overview of water use by area	16
Figure 4: Water source and usage benchmark comparisons for: fully integrated facilities; slaughter, chill and bone facilities; and slaughter and chill facilities	16
Figure 5: Water savings potential for a typical abattoir	17
Figure 6: Piping used for rinsing/manual cleaning	18
Figure 7: Manual cleaning low flow system	19
Figure 8: "Economiser" spray sanitation system	20
Figure 9: Illustration of a hot water/ultrasonic dip tank	21
Figure 10: Examples of hand wash basins with traditional rose fittings	22
Figure 11: Example of an aerator and a touch fitting for conventional taps	22
Figure 12: Example of a boot cleaning station	22
Figure 13: Mounted brush system for cleaning boots	23
Figure 14: Examples of water reuse opportunities	24
Figure 15: Overview of main energy users in an abattoir	27
Figure 16: Total energy source and usage benchmark comparisons for fully integrated facilities; slaughter, chill and bone facilities; and slaughter and chill facilities	27
Figure 17: Electrical energy savings potential for a typical abattoir	28
Figure 18: Time-of-use tariff overview	29
Figure 19: Demand management strategies	30
Figure 20: Live logging profile of a plant with a high refrigeration load	30
Figure 21: Pump system curve illustrating the impact of throttling	31
Figure 22: Waste energy and potential savings illustrated by removing unnecessary head pressure and line throttling	32
Figure 23: The impact of running two pumps on a system designed for one	32
Figure 24: Pump curve of borehole pumps	33
Figure 25: Illustrations of the effect of refrigerant leaks	34
Figure 26: Load matching strategies for air and cooling compressors	34

Figure 27: Typical demand on compressors with reduced plant load	35
Figure 28: Illustration of efficiency loss during unload cycle	36
Figure 29: Overview of heat recovery potential and applications	36
Figure 30: Overview of interventions for compressed air systems	37
Figure 31: New build life cycle cost on different power sources (2016 rates)	38
Figure 32: Thermal energy savings potential for a typical abattoir	39
Figure 33: Vapour compression cycle of a heat pump	40
Figure 34: Illustration of heat recovery on a refrigeration system	41
Figure 35: Solar irradiation map	42
Figure 36: Typical boiler efficiency curve	44
Figure 37: Anticipated generation efficiency of the boiler	45
Figure 38: Radiation loss pictures on steam lines	46
Figure 39: Expected fuel saving through increased condensate return	48

Tables

Table 1: Summary of water saving recommendations	25
Table 2: Overall steam system efficiency	44
Table 3: Radiation loss table for steam lines	47
Table 4: Summary of energy saving recommendations	49

Boxes

Box 1: Best practice for manual cleaning and rinsing	19
Box 2: Best practice for waste heat recovery on compressors	37
Box 3: Best practice for heat recovery on refrigeration units	41
Box 4: Combined heat and power biogas plant	43
Box 5: Best practice for steam piping – insulation for valves and flanges	47

Glossary

APRE	Agri-Processing Resource Efficiency (Project in South Africa)
CHP	Combined Heat and Power
CO₂	Carbon Dioxide
COP	Coefficient of Performance
DNI	Direct Normal Irradiation
GHG	Greenhouse Gas
IFC	International Finance Corporation
IRR	Internal Rate of Return
kg	Kilogram
kWh	Kilowatt-hour
kl	Kilolitre
KPI	Key Performance Indicator
Lairage	Stock-holding pen where animals are held pre-slaughter at an abattoir.
MAS	Manufacturing, Agribusiness and Services
m³	Cubic metres
mm	Millimetre
MWh	Mega Watt hour
NATSURV	National Survey
Offal	The organs of a slaughtered animal, usually divided into: <ul style="list-style-type: none">• Red offal – heart, liver, kidney, tongue• Rough offal – stomachs, intestines, other organs
PPE	Personal Protective Equipment
QAC	Quaternary Ammonium Compound
R	South African Rands
Rendering	Cooking and sterilising of animal waste products not fit for human consumption (i.e. “condemned”), as well as evaporation of moisture to produce a proteinaceous meal. Melted fat is normally recovered for further utilisation, such as tallow production.
RMAA	Red Meat Abattoir Association
SECO	Swiss State Secretariat for Economic Affairs
Solar PV	Solar Photovoltaic
SU	Slaughter Unit is the number of non-bovine species considered equivalent to one bovine animal for abattoir purposes, and is based on the South African standard whereby: <ul style="list-style-type: none">• One cattle animal equals one SU• Two pigs equal one SU• Six sheep equal one SU• Six goats equal one SU• Six small-stock (mixed species) equal one SU
TDS	Total Dissolved Solids
Tonnes CW (tCW)	Carcase Weight – the volume (metric tonnes) of carcase weight processed.
UV	Ultraviolet
VSD	Variable Speed Drive
WBG	World Bank Group

Acknowledgements

The Practical Guide for Improving Resource Efficiency in Red Meat Abattoirs in South Africa was produced as part of a broader International Finance Corporation (IFC) Agri-processing Resource Efficiency (APRE) project in South Africa, aimed to assist companies engaged in agricultural processing to transition to better water and resource efficiency practices. The project is expected to help mitigate water supply risks in the sector, resulting from the water scarcity challenge in South Africa and throughout the region. The project is implemented in partnership with the Swiss State Secretariat for Economic Affairs (SECO) and the Netherlands.

The Practical Guide for Improving Resource Efficiency was developed as part of a resource efficiency benchmarking study for the red meat abattoir sector in South Africa. The study involved benchmarking of the water and energy usage of 21 abattoirs across the country against local and international best practices. The team would like to acknowledge the contribution from all red meat abattoir owners and managers, and other stakeholders who participated in the benchmarking study and provided input into the Best Practice Guide.

The study was managed by Raymond Greig and Rong Chen (IFC). IFC commissioned Resource Innovations Africa (Pty) Ltd and ProAnd Associates Australia (Pty) Ltd to support the collection of information and the analysis, and to provide technical recommendations. We appreciate the effort of the key experts, Darrin McComb (Director, Resource Innovations Africa) and Jon Marlow (Director, ProAnd Associates Australia) and their teams. IFC has partnered with the Red Meat Abattoir Association (RMAA) to facilitate the implementation of the project, and is grateful to Gerhard Neethling (General Manager, RMAA) for coordinating stakeholder engagements and for providing inputs to the report.

The team is also grateful to the World Bank Group (WBG) colleagues for supporting the assessment and providing feedback on the report. We would like to thank Alexander Larionov, Ivan Ivanov, Jerrard Müller, Nonhlanhla Halimana and Robert Peck. Also, many thanks to Bonny Jennings and the full team at ITL Communication and Design for the excellent production of the report.

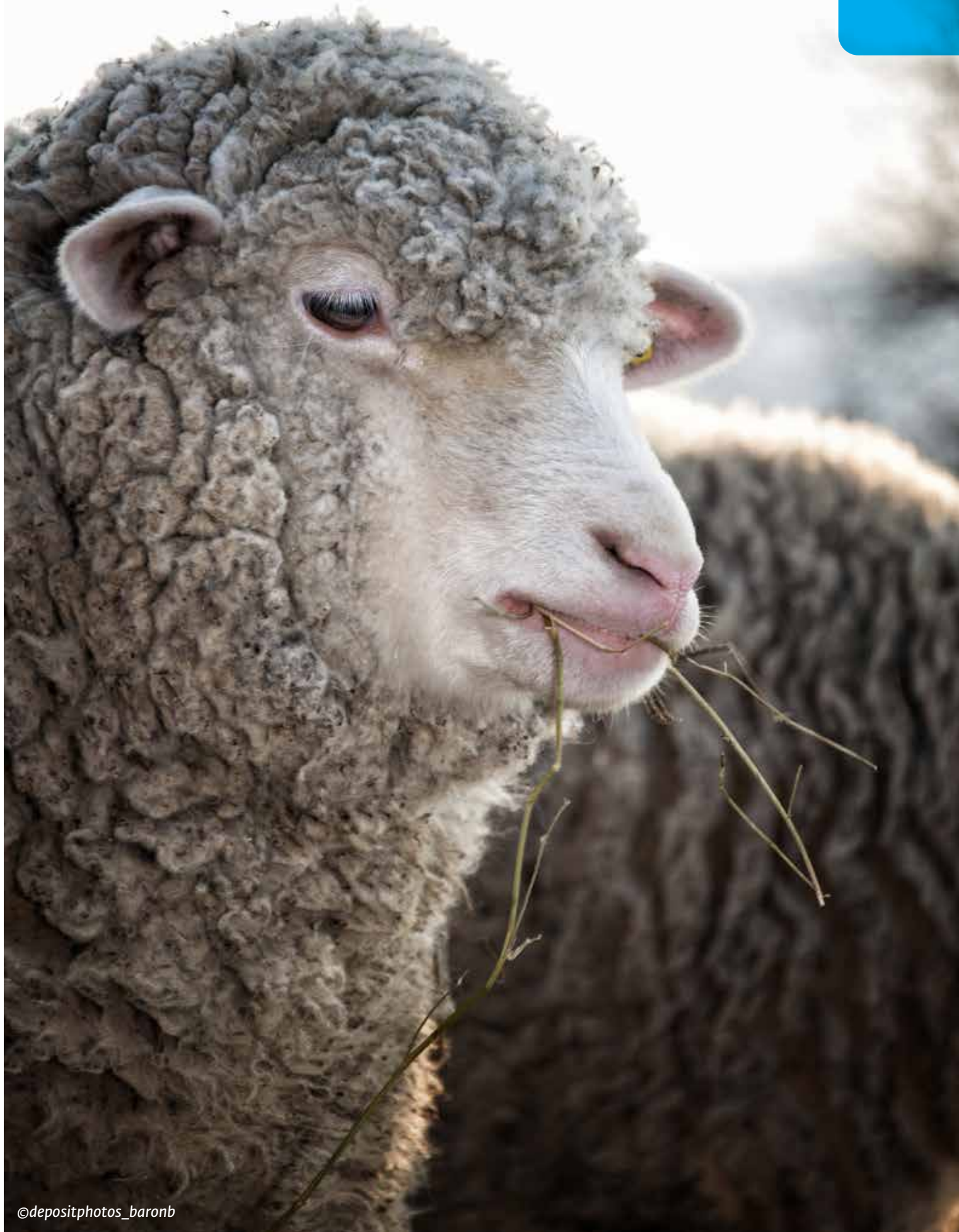

Executive Summary

South Africa's red meat abattoir industry is a key driver of economic growth, as it contributes to value addition, job creation and exports. However, increasing water scarcity, combined with rising costs of energy and fuel, is threatening the competitiveness and sustainability of the sector. The global red meat industry will increasingly come under governmental and consumer scrutiny for its climate footprint. South Africa has one of the lowest costs of energy in the world; however, with increased power shortages, this will likely change.

The APRE project in South Africa was established to address these challenges and help the industry transition to better water and resource efficiency practices. APRE, in partnership with the RMAA, has conducted a resource efficiency benchmarking study and developed this *Practical Guide for Improving Resource Efficiency in Red Meat Abattoirs in South Africa*, with the objective of identifying water and resource efficiency opportunities and proposing practical solutions that the abattoir industry can adopt. These measures will ultimately lead to improved competitiveness and sustainability of the industry.

The red meat industry is a key sub-sector of the agri-processing sector, with 423 abattoirs processing a total of 5.1 million slaughter units (SUs) in 2019. The red meat abattoir industry is also a major water user in the agri-processing sector, utilising an estimated 4.5 million cubic metres of water per year, which amounts to approximately 10% of the water demand of the agri-processing sector (excluding pulp and paper). This study surveyed a sample of 21 abattoirs in South Africa of various sizes, species and geographical locations, and major water and energy saving opportunities were identified. It was determined that there is a potential to reduce water consumption by up to 28% in the industry, resulting in national savings of up to 1.25 million cubic metres and R37 million per annum. Similarly, there is a potential to reduce energy consumption by up to 24% resulting in national savings of up to 92,000 MWh and R105 million per annum. The common resource efficiency opportunities are summarised below.

The South African red meat abattoir industry has the potential to reduce water consumption by up to 28%, resulting in national savings of up to 1.25 million cubic metres and R37 million per annum.

Monitoring Systems

Comprehensive metering and monitoring systems have not been commonly adopted by the industry. Without a metering and monitoring system in place, it is difficult to detect and quantify wastage, including water leaks and house-keeping-related wastage. Abattoirs should ideally be monitoring the areas depicted below with live logging meters on the water and electrical feeds to the plant. Detailed monitoring systems will typically see a 5% reduction in resource consumption.

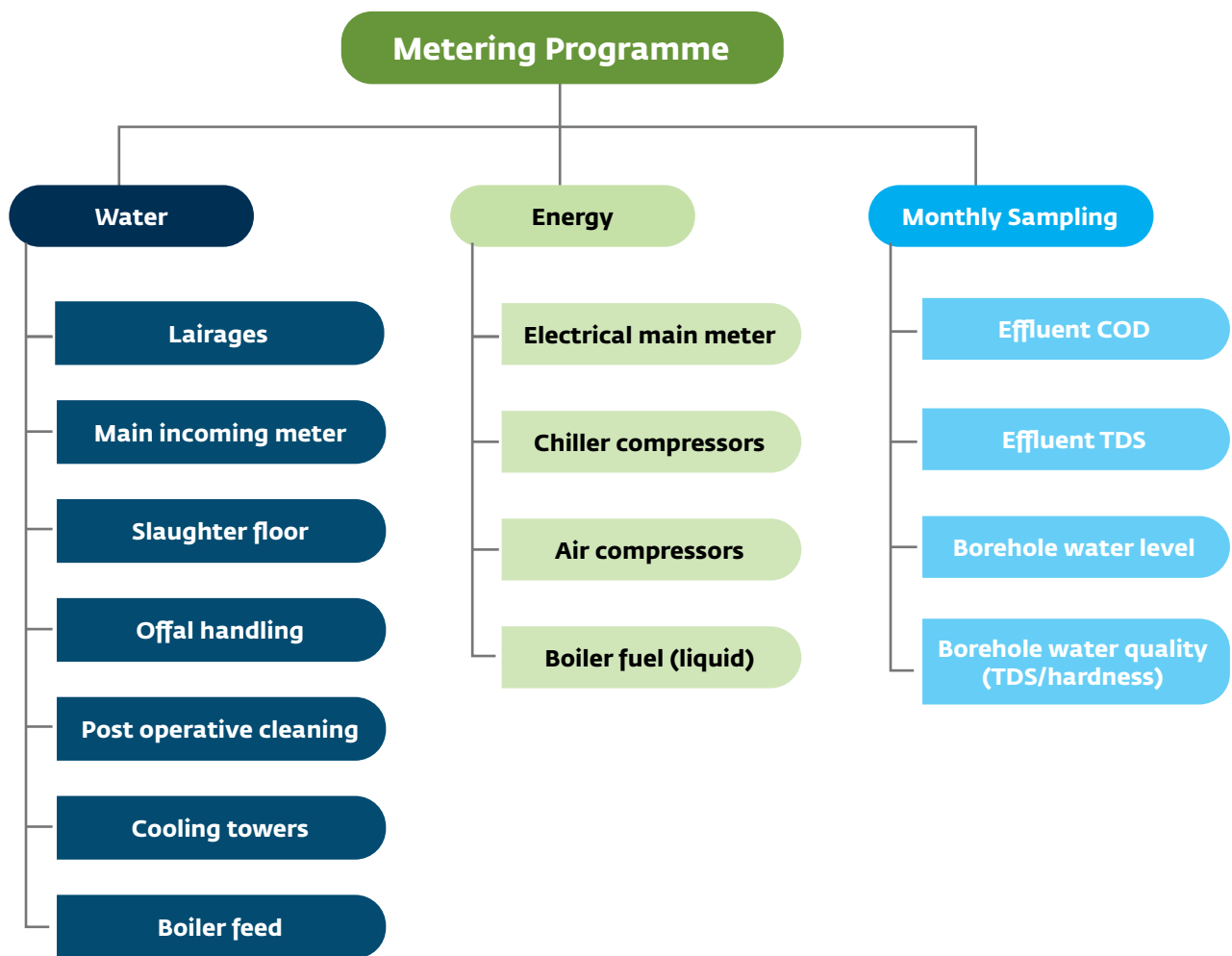

Water

Abattoirs predominantly utilise water from either municipal or ground water sources, with the bulk of the water used for cleaning and sanitation purposes. Whilst abattoirs within the municipal boundaries are faced with higher water costs, those in the rural areas have lower costs, yet their challenges are related to water availability. A typical abattoir could reduce its water consumption by 27.5% by implementing a number of water efficiencies measures. The graph below provides an indication of the expected savings in the respective areas.

THE WATER EFFICIENCY MEASURES IDENTIFIED INCLUDE:

- Implement a ground water strategy
- Rainwater recovery
- Optimise manual cleaning/rinse systems
- Dry cleaning techniques
- Optimise knife and hook sanitation systems
- Optimise boot and hand washing
- Water re-use opportunities

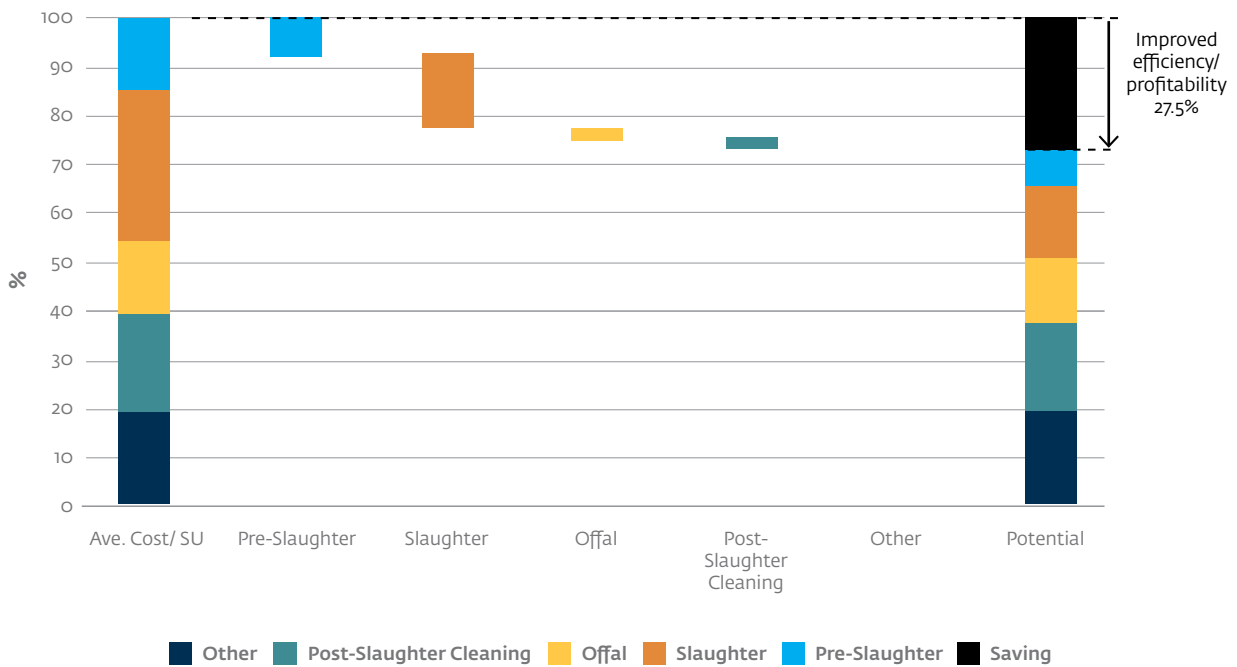

THE ELECTRICAL ENERGY EFFICIENCY AND RELATED COST-SAVING MEASURES IDENTIFIED INCLUDE:

- Review electrical tariffs
 - Reduce peak electrical demand
 - Pump system optimisation
 - Chiller system coefficient of performance (COP) management and optimisation
 - Compressed air system optimisation
 - Solar photovoltaic (PV)
-

Electrical Energy

Refrigeration and chiller plants typically account for up to 45% of the electrical demand of an abattoir and therefore offer the greatest electrical savings opportunities. A typical abattoir could reduce its electrical energy consumption by an estimated 12% by implementing a number of energy efficiency measures.

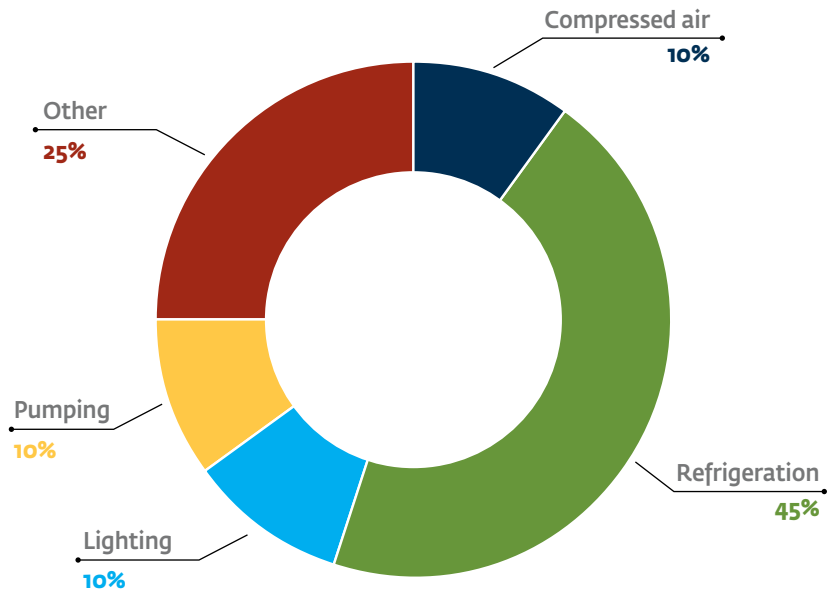

@depositphotos_temis1964

Thermal Energy

The larger plants with on-site rendering would typically have steam systems utilising coal boilers. Smaller abattoirs without rendering capability would utilise either electrical heating elements or small liquid fuel-driven steam systems (flash steam generators). The fuel cost per kilowatt-hour (kWh) is relatively high in the smaller plants; however, their system efficiencies are significantly better, especially for point-of-use heating applications (heating elements at the sterilisers). There is significant scope for improving costs and efficiencies in the thermal heating systems, especially in the smaller plants that have relatively high heating costs per kWh. A typical abattoir could reduce its thermal energy consumed by an estimated 32% by implementing a number of thermal energy efficiency measures.

THE THERMAL EFFICIENCY AND RELATED COST-SAVING MEASURES IDENTIFIED INCLUDE:

- Renewables and waste heat recovery
 - Optimise steam system generation efficiency
 - Insulate steam lines, valves and flanges
 - Condensate recovery
-

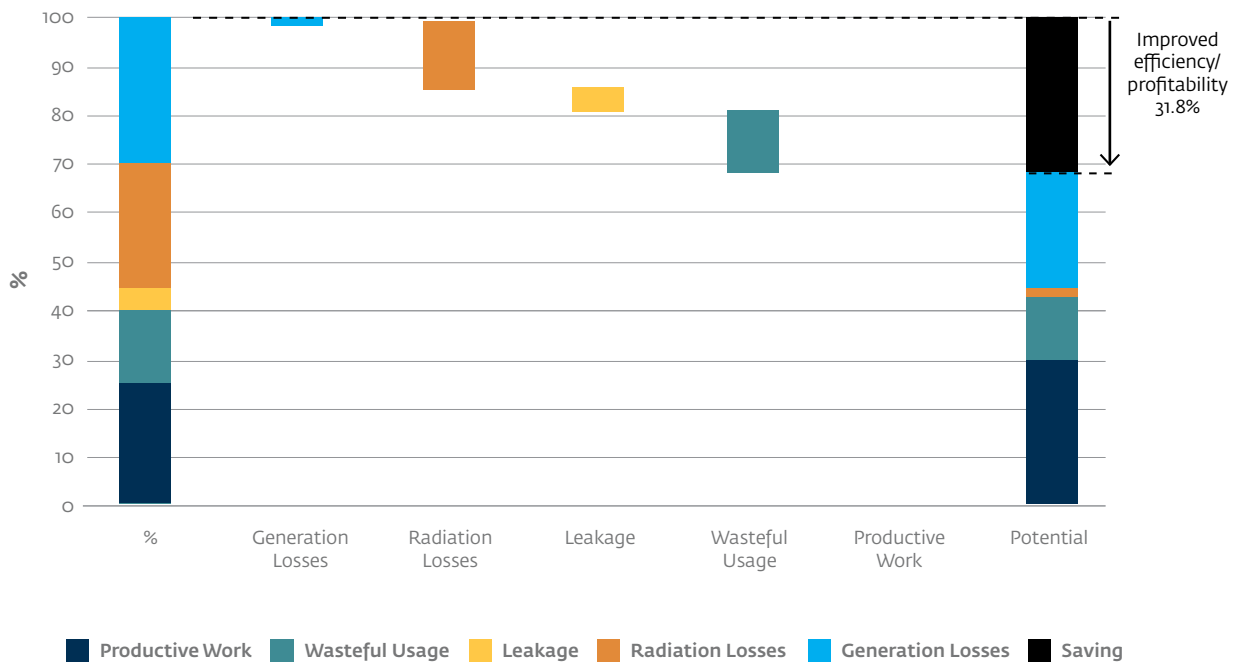



Background

South Africa is a water-scarce country. By 2030, South Africa's water demand is expected to exceed its water supply by up to 17% (a deficit of 2.7-3.8 billion kl) and the forecasted growth in the agri-processing sector will contribute to this widening gap between water supply and demand¹. South Africa's agri-processing sector is a key driver for the economy as it contributes to value addition, job creation and exports. However, increasing water scarcity, combined with rising costs of energy and fuel, is threatening the competitiveness and sustainability of the sector. IFC's Manufacturing, Agribusiness and Services (MAS) Advisory team, in partnership with SECO, launched the four-year APRE project in South Africa to address market challenges and help the industry transition to better water and resource efficiency practices. The programme aims to improve water use efficiency, reduce overall water consumption, and mitigate water supply risks in the sector.

The red meat industry is a key sub-sector of the agri-processing sector, with 423 abattoirs of various sizes processing a total of 5.1 million SUs in 2019^{2,3}. The red meat abattoir industry is also a major water user in the agri-processing sector, utilising an estimated 4.5 million kl of water per year, which amount to approximately 10% of the water demand of the agri-processing sector (excluding pulp and paper)⁴. The sector possesses significant potential to reduce the use of water and other resources, which would improve its cost base and environmental footprint, and increase the competitiveness and sustainability of abattoirs and integrated operators, as well as enhance their export potential. IFC has partnered with the RMAA to conduct a resource efficiency benchmarking study and this *Practical Guide for Improving Resource Efficiency in Red Meat Abattoirs in South Africa*, with the objective of identifying water and other resource efficiency opportunities and practical solutions that abattoirs can adopt.

The Study surveyed 21 abattoirs (including single species abattoirs for cattle and pigs, and mixed species abattoirs for cattle, pigs and goats). The abattoirs were selected to be representative of the sector and therefore include high throughput abattoirs (>20 SUs per day) as well as low throughput abattoirs (2-20 SUs per day) which are geographically spread across the country.

DATA FOR THIS REPORT HAS BEEN COLLECTED FROM A VARIETY OF SOURCES, INCLUDING:

- Plant monitoring data
 - In-plant surveys by the project team
 - Accounting documentation
 - Energy and material audit tools
 - Desk study of international benchmarking.
-

¹ World Bank Group, 2020

² Red Meat Levy Admin, 2019

³ IFC, 2020

⁴ IFC, 2019

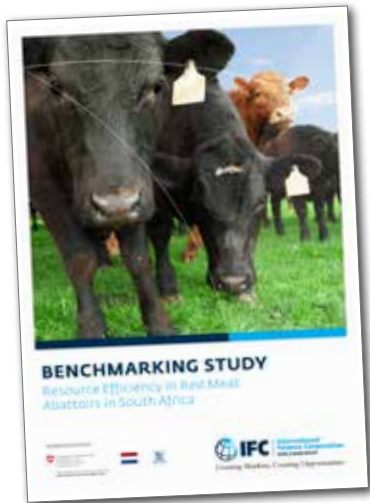

Details of the Study are included in IFC's *Benchmarking Study: Resource Efficiency in Red Meat Abattoirs in South Africa*.

This document has been specifically prepared for South African red meat abattoirs and therefore focuses on the most prominent opportunities for the sector, taking into account the existing operating environment. To have a comprehensive list of resource efficiency best practices and opportunities, this document should be read in conjunction with other reputable and complementary South African and international publications such as the Water Research Commission's NATSURV7 on Water and Wastewater Management in the Red Meat Abattoir Industry (2017).

The sections to follow describe a number of resource efficiency opportunities and best practices that have been identified during the study. First, a metering and monitoring system is recommended which is applicable to both water and energy consumption. This is followed by water efficiency measures, electrical energy efficiency measures and finally thermal energy efficiency measures. For each of these sections, current practices are described, opportunities are identified, recommended actions are outlined, potential problems are raised, and an indicative cost-benefit analysis is provided based on 2020 costs.



Monitoring Systems

Implement an Effective Metering and Monitoring System

Observation

Detailed water balances were compiled at abattoirs during the assessment, which showed that roughly 10% of the water utilised was lost to observable leaks, while a further 15-25% of the water utilised could not be accounted for and was likely lost to underground leaks.

On ageing production facilities with piping systems underground, it is possible for water leaks to go undetected for long periods of time. In addition, if effective metering and monitoring is not conducted, it is difficult to detect and quantify house-keeping-related wastage. Live monitoring systems are effective in not only quantifying water and energy consumption but also in understanding usage patterns. Tracking downtime readings (over holidays or weekends) often provides a clear indication of potential leaks and avoidable losses.

Abattoirs should ideally be monitoring the following areas:

RECOMMENDED ACTION

1. Install live logging meters on the water and electrical feed to the plant.
2. Develop a monitoring programme with targets for key consumption areas.
3. Implement a leak detection and repair programme.

INDICATIVE COST-BENEFIT ANALYSIS

Detailed monitoring systems will typically see a 5% reduction in resource consumption.

FIGURE 1: RECOMMENDED METERING PROGRAMME

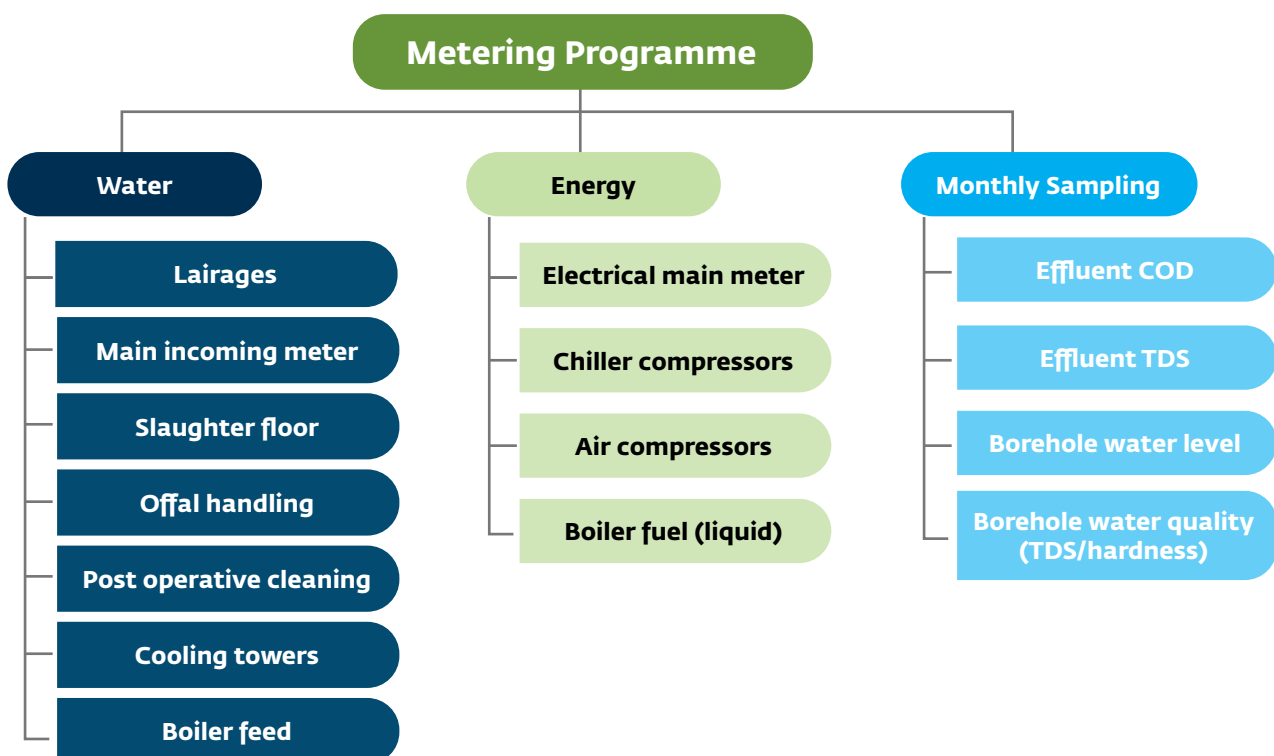



Water

South Africa is considered a water-scarce country with average annual rainfall of just under 500 mm and just 843 m³ per capita per annum water availability. Figure 2 provides an indication of how South Africa compares against other countries.

FIGURE 2: WATER AVAILABILITY PER PERSON PER YEAR IN SELECTED COUNTRIES⁵

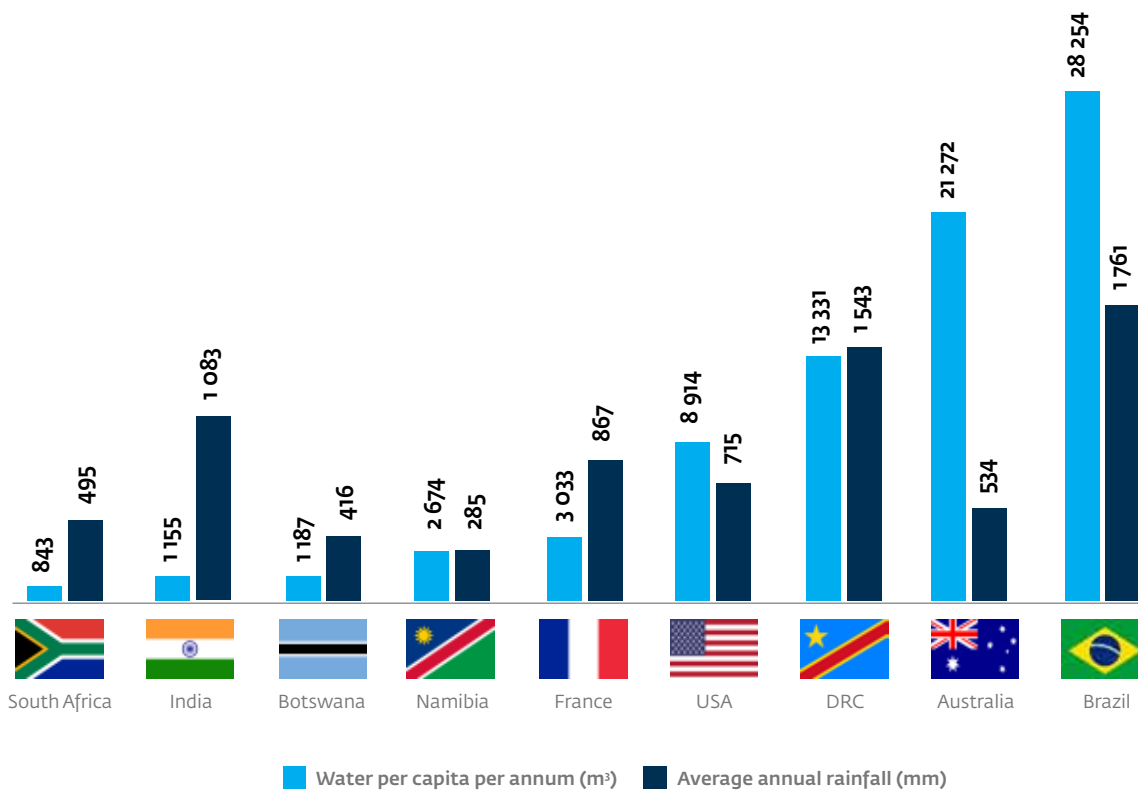

The red meat sector is a significant water user and has been identified as one of the sectors that could benefit from optimisation studies.

Abattoirs utilise water predominantly from either municipal or ground water sources. Abattoirs based in a metropolitan area would typically purchase water at a rate of between R20–R40/kl and discharge at a cost which would range between R20–R80/kl, depending on the quality of the water discharged. Abattoirs in rural areas would typically extract from boreholes and discharge the water to irrigation or evaporation ponds. The costs involved in these instances would be for pumping (~R1–R2/kl) and chemical treatment (chlorination). Abattoirs that irrigate their effluent invariably make use of biological treatment ponds prior to spraying the water to reduce the organic loading.

⁵ World Wildlife Fund, 2016

FIGURE 3: OVERVIEW OF WATER USE BY AREA

The bulk of the water used in a typical abattoir would be for cleaning and sanitation purposes. Figure 3 provides an indication of the distribution of water consumption in these facilities.

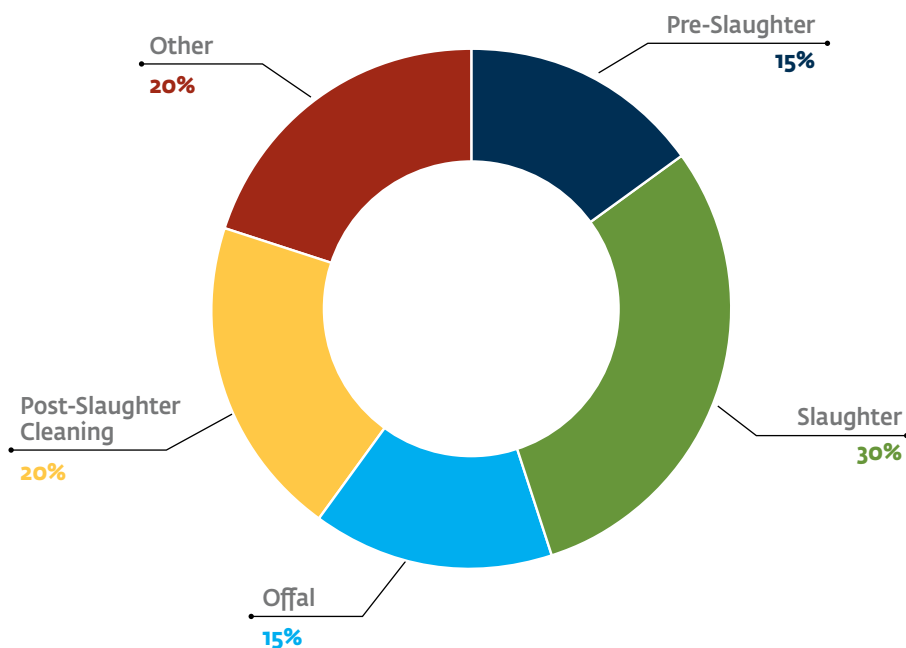

Abattoirs' water consumption and specific water usage is provided in Figure 4 below.

FIGURE 4: WATER SOURCE AND USAGE BENCHMARK COMPARISONS FOR: FULLY INTEGRATED FACILITIES; SLAUGHTER, CHILL AND BONE FACILITIES; AND SLAUGHTER AND CHILL FACILITIES

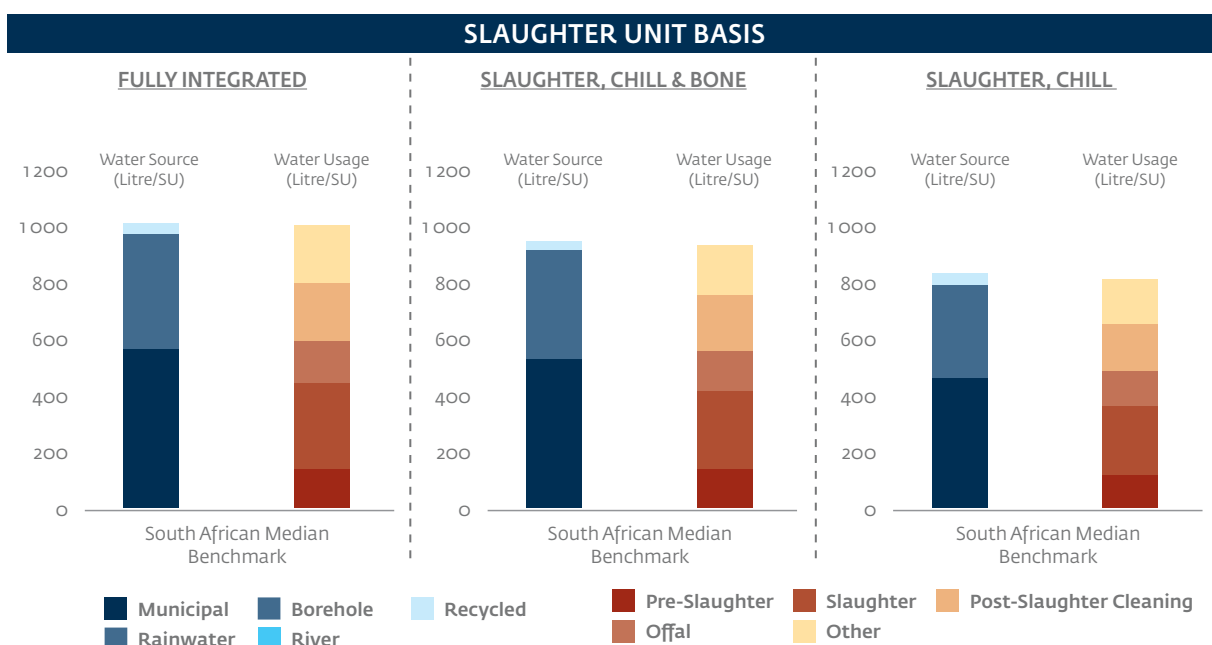

The water usage South African benchmarks for fully integrated facilities; slaughter, chill and bone facilities; and slaughter and chill facilities were determined to be 1 000 l/SU, 950 l/SU and 800 l/SU, respectively.

While the pressure on abattoirs within municipal boundaries relate to cost, the pressure on those in the rural areas relate to water availability. A typical abattoir could reduce its water consumption by 27.5% by implementing water efficiencies measures. Figure 5 provides an indication of the expected savings in the respective areas.

FIGURE 5: WATER SAVINGS POTENTIAL FOR A TYPICAL ABATTOIR

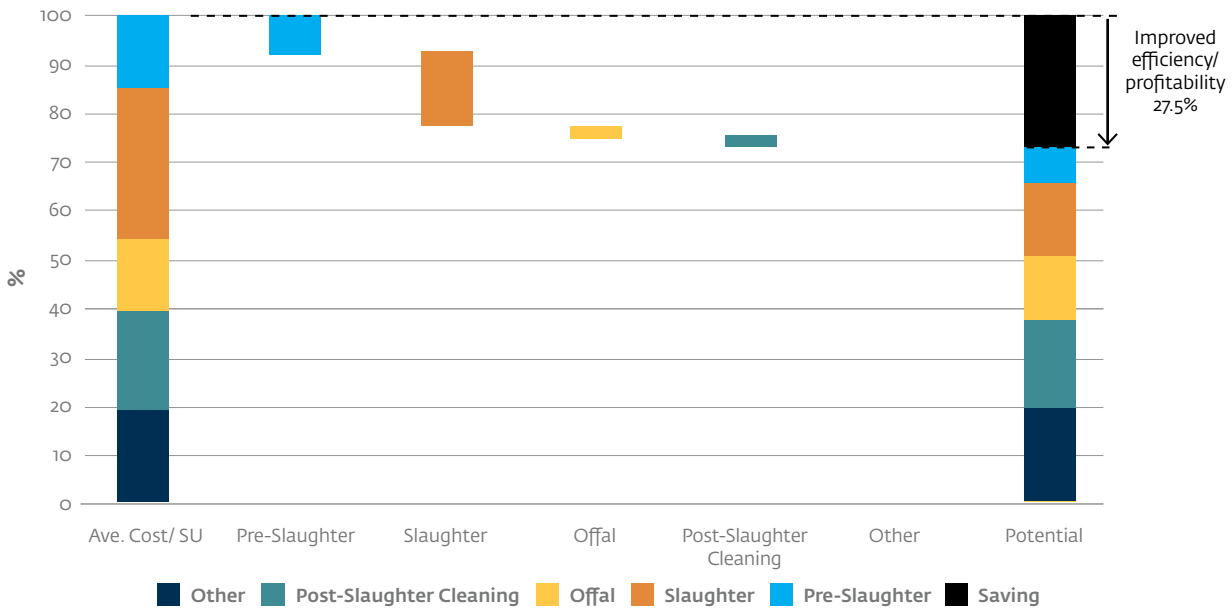

The following sections focus on these water minimisation opportunities.

Water Supply

Ground Water Strategy

Observation

None of the abattoirs utilising ground water monitored the levels on an ongoing basis. A few abattoirs had issues with limited yield in the boreholes, which necessitated drilling additional wells.

Ground water is a limited resource and extensive extraction will lead to resource constraints. Organisations should develop strategies that look at minimising the use of or replenish the reserves they are depleting. International best practice considers replenishment of ground water reserves at a rate of 200% of extraction as sustainable.

Water levels on ground reserves should be monitored routinely to understand what the reserves are and whether they are depleting.

Rainwater Recovery

Observation

South Africa is a water-scarce region with average annual rainfall of under 600 mm and increasingly limited supply due to current and recurring drought conditions. Rainwater in general is fairly clean, with low hardness levels, making it suitable for cooling tower and boiler systems.

Potential Issues/Problems

Rainwater may contain microbial and chemical impurities and may need to be treated prior to inclusion in the plant. Rainwater should be bacteriologically tested before use.

RECOMMENDED ACTION

1. Install pressure probes on each borehole at the discharge point.
2. Monitor ground water reserve levels using pressure sensors on borehole pump supply.
3. Develop a drought event strategy which requires the plant to reduce its extraction by 60%.

RECOMMENDED ACTION

1. Install lined dams to recover rainwater from the site.
2. Recover rainwater from rooftops.
3. Re-use water in lairage washdown or as make-up for cooling condensers.

Water Usage

Optimize Manual Cleaning/Rinse System

Observation

Extensive use of hoses for manual cleaning as well as personal rinsing was noted during the site visits, specifically in the slaughter areas. Many pipes had no directional nozzles or shut-off valves, with flow rates between 15-30 l/min. Water for personal cleaning (apron rinsing), floor washing and post-slaughter processes often exceeded 50% of the water used in the abattoir. These volumes could be reduced by 30-50% by installing directional nozzles and automatic shut-off valves.

Some examples of pipes without valves left running or used for apron rinsing are provided in Figure 6.

FIGURE 6: PIPING USED FOR RINSING/MANUAL CLEANING



Manual cleaning (personal and floor cleaning) systems can be optimised using restriction orifices and shut-off valves on the end of the pipe. An example of a low flow, low pressure fan spray is illustrated in Figure 7. These systems reduce water utilisation for cleaning by approximately 50% while increasing the cleaning efficacy.

RECOMMENDED ACTION

1. Fit directional restriction nozzles.
2. Locate hose points close to the point of use.
3. Install automatic shut-off valves on the end of the hoses.

FIGURE 7: MANUAL CLEANING LOW FLOW SYSTEM



Potential Issues/Problems

The correct nozzles for the boosted pressure systems are often stolen or removed. Consideration should be given to issuing nozzles to staff as a part of their personal protective equipment (PPE).

Indicative Cost-benefit Analysis

It is conservatively estimated that a 50% reduction in water usage (a reduced flow from 20 l/min to 10 l/min) could be achieved for the above processes using restriction orifices. The couplings can be installed cost effectively, with a cost of R1 000 per point budgeted for.

BOX 1:
BEST PRACTICE FOR MANUAL
CLEANING AND RINSING

The picture below is of a abattoirs with point-of-use water pipe dropdowns, with both an auto shut-off valve and a manual shut-off valve and directional nozzle.



RECOMMENDED ACTION

1. Develop an organics weighing system for cleaning and shift staff to quantify organic debris on the floor.
 2. Develop key performance indicators (KPIs) to ensure process staff keep product spillages to a minimum.
 3. Employ dry cleaning techniques as a primary method for managing organics in all areas prior to post-slaughter cleaning (especially in the lairages where most problems occur).
-

Dry Cleaning Techniques

Observation

The norm for cleaning staff is to rinse excess organics/product down the drain. Much of this will be recovered on the effluent static screen, but in the process suspended solids will be degraded and ultimately contribute to the organic load that has to be treated by the effluent treatment system.

Dry cleaning systems should be adopted to reduce water usage and ingress of organics into the effluent treatment systems. Specific objectives and targets should be incorporated for production staff and incentives used to encourage good habits/behaviour.

Potential Issues/Problems

Managing staff efficacy and culture is normally difficult and will require a concerted effort by management.

Indicative Cost-benefit Analysis

The cost savings would be in terms of improved yield on the processing and by-products lines.

FIGURE 8: "ECONOMISER" SPRAY SANITATION SYSTEM



Optimise Knife and Hook Sanitation Systems

Observation

All of the abattoirs surveyed utilised overflow hot water systems for knife sterilisation. Invariably, these are boosted to the required temperature with electrical elements at the point of use, or steam is used to maintain the temperature.

Conventional hot water overflow knife sterilisation systems and hook spray systems use significant amounts of energy and water. The aim of the process is to effectively sanitise the equipment by exposing it to elevated temperatures for a set period.

New systems of sanitation, including dry (UV sterilisation) and on-demand "spray" systems significantly reduce the amount of hot water/steam used while improving the cleaning and sanitation efficacy. An electrically heated spray system is depicted in Figure 9. The unit supplies 120 ml of hot water per sterilisation cycle, which is a significant saving on the 0.5-2 l/min of conventional overflow systems. Should overflow systems be prescribed, consideration should be given to installing double-skin or otherwise insulated sterilisers which will reduce the hot water flow rate required to maintain temperatures.

Spray-type hook and viscera sanitation systems may not achieve the desired microbiological outcome; alternative dip tank systems may be a solution for hooks, skids and other conveyor systems.

FIGURE 9: ILLUSTRATION OF A HOT WATER/ULTRASONIC DIPTANK⁶

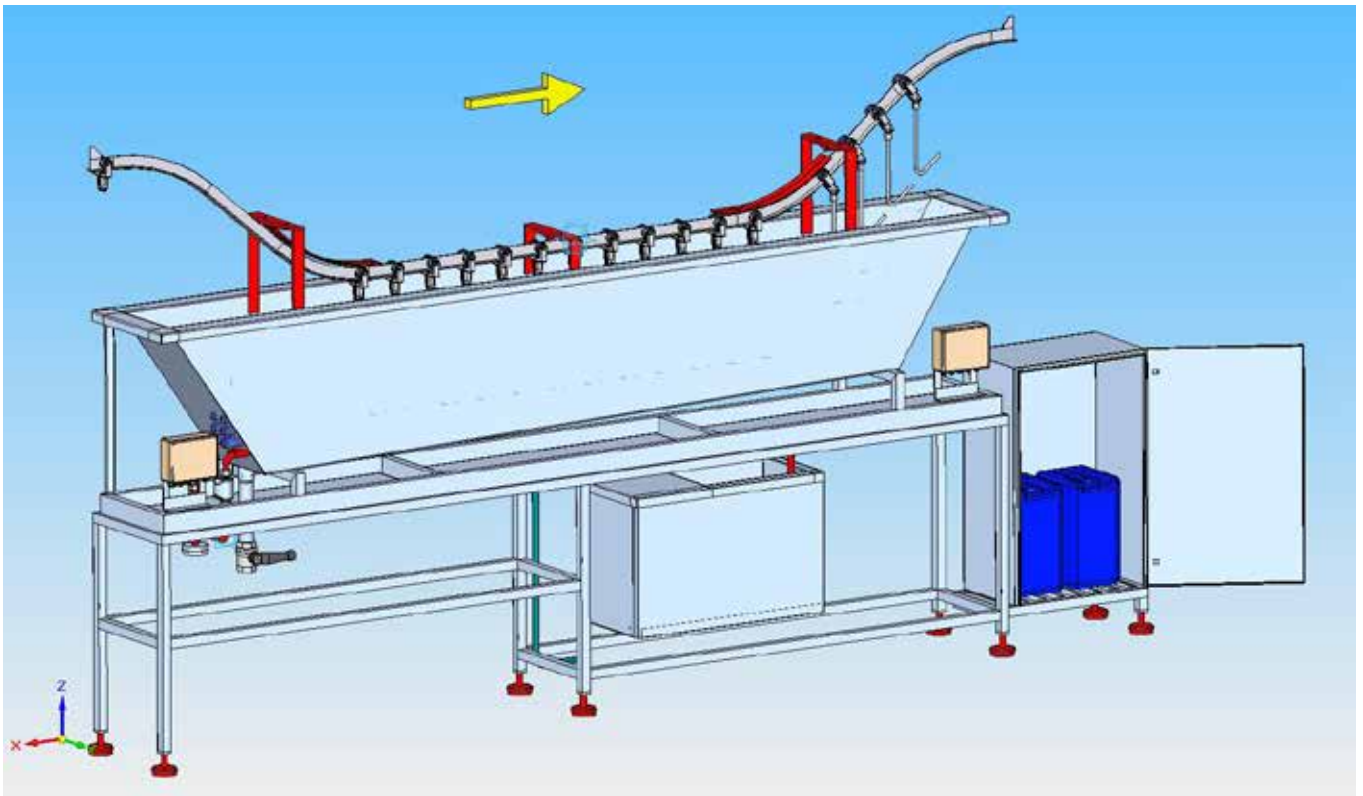

Should spray systems be used for the hook cleaning and viscera table, these should be interlocked to ensure turning off when the line is not operating.

Potential Issues/Problems

Hygiene inspectors may not approve of the application of this technology; it would therefore be a sound strategy to address approval from the relevant authorities. Consideration should be given to providing a visual temperature display to prove the required temperatures are being met while sterilising.

Indicative Cost-benefit Analysis

The cost of the water used at this step would vary between R50-R140/kl depending on the heating system and the cost of water. A knife steriliser would use between 2-5 l/min which equates to 250-600 kl/annum. Each knife steriliser therefore costs in the vicinity of R12 500-R35 000/annum to operate, depending on the flow rate setting, the cost of water and the cost of energy.

This cost could be reduced by over 80% through implementing spray sterilisers, low flow insulated sterilisers or alternate technologies. There would be a two- to three- year payback period on implementing alternative sanitation systems for knife and hook sterilisers.

RECOMMENDED ACTION

1. Introduce spray sterilisation, double-skin (insulated) systems or low flow hot water sprays.
2. Use an immersion tank for hook sanitation.
3. Interlock sprays to ensure they are not operating while the line is not running.

⁶ Christeyns, 2017

FIGURE 10: EXAMPLES OF HAND WASH BASINS WITH TRADITIONAL ROSE FITTINGS



RECOMMENDED ACTION

1. Install low flow/mist taps and boot brush stations.

Optimise Boot and Hand Washing

Observation

Effective hand, boot and apron washing is important for hygiene requirements but is often an area that sees significant water losses.

Hand and boot wash stations utilise conventional water faucets and hoses, and account for roughly 5-10% of the facility's water consumption. Typically, the water is heated to 45°C, with the cost in the vicinity of R40-R80/kl depending on the cost of water and energy for the plant.

Plants typically utilise conventional shower head fittings for hand and boot washing as depicted in Figure 11.

Hand wash station usage can be significantly reduced by fitting low flow restriction nozzles that would also improve the cleaning efficacy of the handwashing process by ensuring staff members take longer to rinse the soap off their hands. The atomisation spray also requires staff members to rub the soap off their hands, which further improves cleaning efficacy.

A cheaper alternative to a mist nozzle is a touch-demand nozzle with aerator as shown in Figure 12.

In addition, the conventional boot washing process does not adequately address the bottom of boots, as this would require standing on one leg while trying to clean.

FIGURE 11: EXAMPLE OF AN AERATOR AND A TOUCH FITTING FOR CONVENTIONAL TAPS



One-touch tap - 90% H₂O saving



Neoperl Cascade Aerator - 84% H₂O saving

FIGURE 12: EXAMPLE OF A BOOT CLEANING STATION



Boots can be more effectively cleaned using a system as shown in Figure 14 where the staff member holds the rail and pushes the boot through the brush system. A quaternary ammonium compound (QAC) or chlorine sanitiser can be sprayed onto the brush system periodically.

FIGURE 13: MOUNTED BRUSH SYSTEM FOR CLEANING BOOTS



Potential Issues/Problems

Thin mist sprays may block up due to particles/sediment in the water system. This can be averted by installing a serviceable filter ahead of the hand wash station.

Indicative Cost-benefit Analysis

There could be a 60-80% reduction in warm water consumption in these areas.

Water Reuse Opportunities

Observation

Some wastewater streams are relatively clean and may be used elsewhere in the plant for activities that do not require high quality water. The key to water reuse is the ability to segregate suitable wastewater streams from the main wastewater drainage system, and to ensure that the reused water is bacteria free.

To determine the best opportunities for water reuse, the quantities and the quality of water available for each reuse stream should be estimated and matched up with the quantities required for each potential application, as shown in Figure 15.

FIGURE 14: EXAMPLES OF WATER REUSE OPPORTUNITIES⁷



RECOMMENDED ACTION

Recover evaporative condenser bleed and use for cleaning in the lairages.

Consider reusing steriliser and water in the scald tanks in abattoirs processing pigs.

Ensure reused water is bacteriologically tested before use and periodically during use.

Many abattoirs utilise evaporative condensers which account for roughly 10-15% of the water usage on the plant. The bleed rate on these condensers, depending on the water quality, would range between 20-30%. This water could be recovered and reused for lairage washdown.

Additional reuse opportunities are outlined in Figure 15, but these should be considered in close consultation with the health inspectorate.

Potential Issues/Problems

Current red meat hygiene standards in South Africa typically do not allow for the reuse of water on edible products or in a process where the water could come into contact with edible products, and therefore reuse opportunities are limited.

⁷ Meat and Livestock Australia Ltd, 2002

Summary of Water Efficiency Recommendations

The expected savings through the implementation of the described measures is in the vicinity of 25-35%. The main savings relate to manual cleaning in the pre-slaughter and slaughter processes. A summary of the recommendations is provided in Table 1.

TABLE 1: SUMMARY OF WATER SAVING RECOMMENDATIONS

SECTION	RECOMMENDED ACTIONS	POTENTIAL SAVINGS
Ground water strategy	<ol style="list-style-type: none"> 1. Install pressure probes on each borehole at the discharge point. 2. Monitor ground water reserve levels using pressure sensors on borehole pump supply. 3. Develop a drought event strategy which requires the plant to reduce its extraction by 60%. 	n/a
Rainwater recovery	<ol style="list-style-type: none"> 1. Install lined dams to recover rainwater from the site. 2. Recover rainwater from rooftops. 3. Reuse water in lairage washdown or as make-up for cooling condensers. 	n/a
Optimise manual cleaning/rinse system	<ol style="list-style-type: none"> 1. Fit directional restriction nozzles. 2. Locate hose points close to the point of use. 3. Install automatic shut-off valves on the end of hoses. 	50% of water usage for these processes.
Dry cleaning techniques	<ol style="list-style-type: none"> 1. Develop an organics weighing system for cleaning and shift staff to quantify organic debris on the floor. 2. Develop KPIs to ensure that process staff keep product spillages to a minimum. 3. Employ dry cleaning techniques as a primary method for managing organics in all areas prior to post-slaughter cleaning (especially in the lairages where most problems occur). 	The cost savings would be in terms of improved yield on the processing and by-products lines.
Optimise knife and hook sanitation systems	<ol style="list-style-type: none"> 1. Introduce spray sterilisation, double-skin (insulated) systems or low flow hot water sprays. 2. Utilise an immersion tank for hook sanitation. 3. Interlock sprays to ensure they are not operating while the line is not running. 	Up to 80% of water used by knife and hook sanitation systems.
Optimise boot and hand washing	<ol style="list-style-type: none"> 1. Install low flow/mist taps and boot brush stations. 	60-80% reduction in warm water consumption in these areas.
Water reuse opportunities	<ol style="list-style-type: none"> 1. Recover evaporative condenser bleed and use for cleaning in the lairages. 2. Consider reusing steriliser and water in the scald tanks in abattoirs processing pigs. 3. Ensure reused water is bacteriologically tested before use and periodically during use. 	n/a



Energy

Abattoirs typically utilise both electrical and thermal energy. The main users of electrical energy are the refrigeration and chiller plants (~45%), the air compressors and pumps (~10% each) and heating elements (sterilisers and geysers ~20%). Where electrical heating elements are not used, thermal energy is used to heat water for cleaning and sterilisers.

The specific energy use for abattoirs is provided in Figure 16.

FIGURE 15: OVERVIEW OF MAIN ENERGY USERS IN AN ABATTOIR

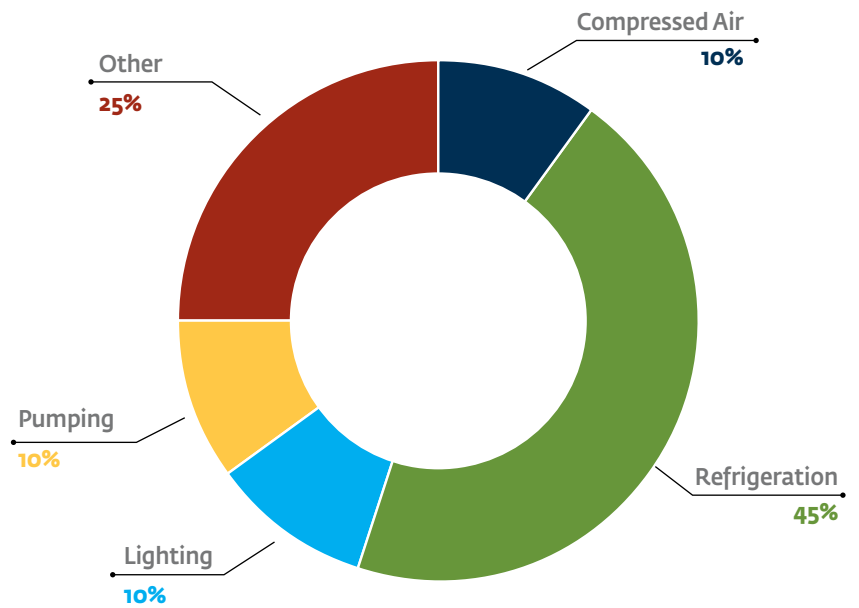
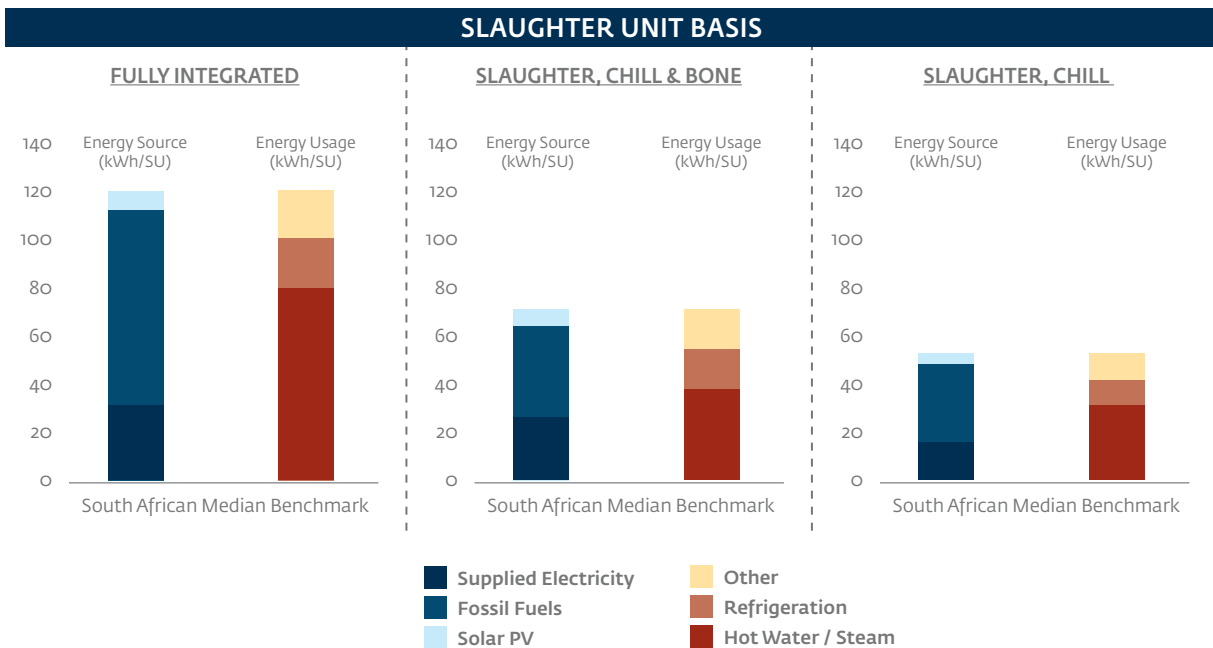

FIGURE 16: TOTAL ENERGY SOURCE AND USAGE BENCHMARK COMPARISONS FOR FULLY INTEGRATED FACILITIES; SLAUGHTER, CHILL AND BONE FACILITIES; AND SLAUGHTER AND CHILL FACILITIES



The total energy usage South African benchmarks for fully integrated facilities; slaughter, chill and bone facilities; and slaughter and chill facilities were determined to be 120 kWh/SU, 75 kWh/SU and 55 kWh/SU, respectively.

The following sections are split by electrical and thermal energy, and review common recommendations made as well as the indicative savings.

Electrical Energy

A typical abattoir could reduce the electrical energy it consumes by an estimated 12% by implementing a number of energy efficiency measures. Figure 18 provides an indication of the expected savings in the respective areas.

FIGURE 17: ELECTRICAL ENERGY SAVINGS POTENTIAL FOR A TYPICAL ABATTOIR

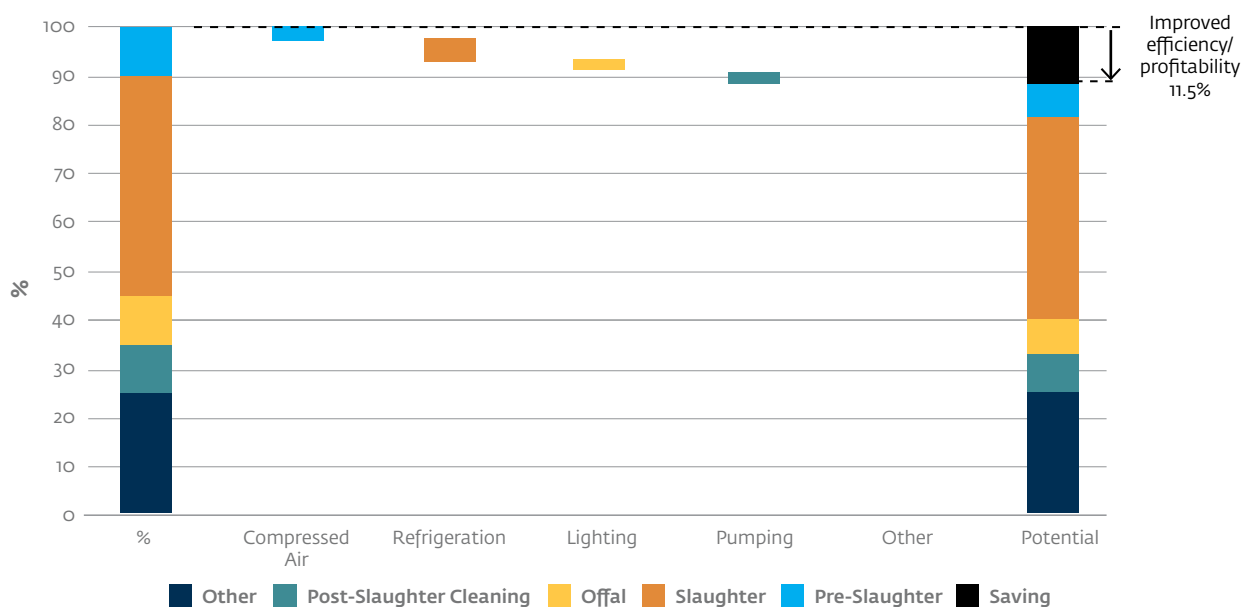

The following sections focus on these electrical energy minimisation opportunities.

Review Electrical Tariff

Observation

Abattoirs based in metropolises typically purchase their electricity from the municipality and are charged on a demand tariff basis where electrical usage is covered at a set rate ranging between R0.80-R1.00/kWh and the demand charges at rates of R200-R250/kVA. The peak demand would account for between 40-50% of the total bill. The average electrical cost (total cost of electrical energy divided by the electrical energy kWh consumption) would be in the vicinity of R1.40-R1.65/kWh on this tariff. Abattoirs based in rural areas usually purchase electricity on the Eskom rural time-of-use tariff which is the cheapest available option and their electrical costs would range between R1.00-R1.30/kWh. The time-of-use tariffs are summarised in Figure 19. The high demand season coincides with the winter months June to August and the rates increase in proportion to the increased grid demand.

FIGURE 18: TIME-OF-USE TARIFF OVERVIEW⁸

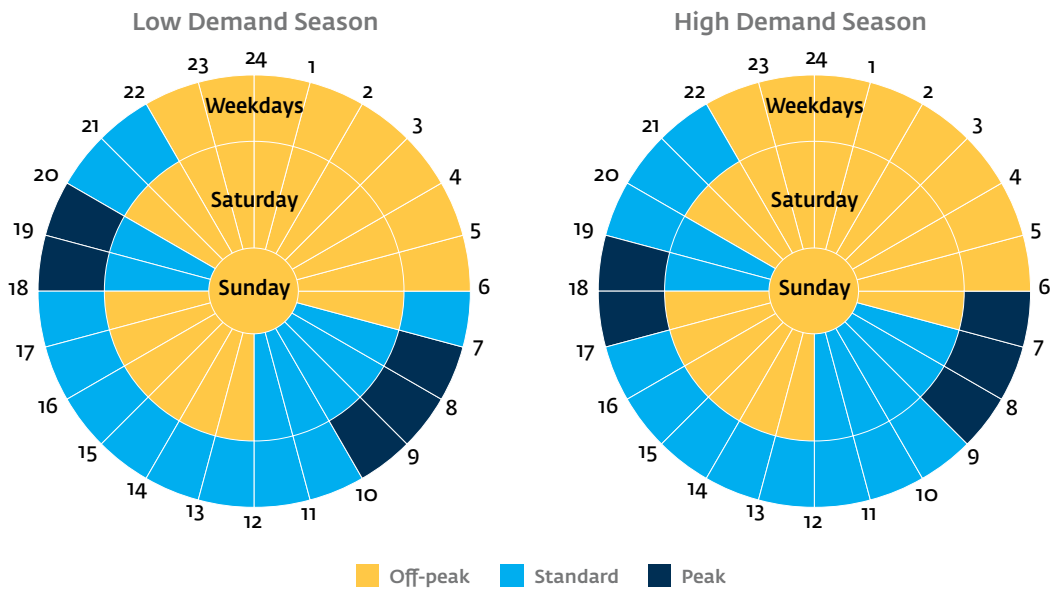

Abattoirs' main energy user would be the refrigeration plant which would draw power on a 24-hour basis. A time-of-use tariff would usually be favourable for companies that have a fixed constant demand. As a rule of thumb, if the blended cost for electrical power purchase (total cost divided by the total kWh) exceeds R1.50/kWh, it would be prudent to review the available tariffs. Typically, municipalities and Eskom will do the tariff comparison for the abattoir, but this comparison would have to be requested formally.

RECOMMENDED ACTION

1. Request a tariff review from the local authority or Eskom.
-

Potential Issues/Problems

Tariff changes can typically only be done once a year.

Indicative Cost-benefit Analysis

Tariff changes can result in savings of between 10-20% of the cost of electricity.

Reduce Peak Electrical Demand

Observation

Abattoirs are either on a time-of-use tariff or a peak demand tariff. Both tariffs will typically contain a peak demand cost (the highest draw in power over a 30-minute period in the month). This cost would account for 20-40% of the bill.

Demand is the average rate at which energy is used during a 30-minute time period called the demand interval and the "peak demand" is the highest average load (kVA) reached over all the demand intervals within a given billing period. One half-hour period will determine the rate for the entire month. These costs can be reduced by either conserving power (e.g. reducing compressed air leaks), clipping the peak (e.g. turning off equipment during peak times) or shifting the load outside of peak times (e.g. utilising a timer on a heat pump).

⁸ Eskom, 2019

FIGURE 19: DEMAND MANAGEMENT STRATEGIES

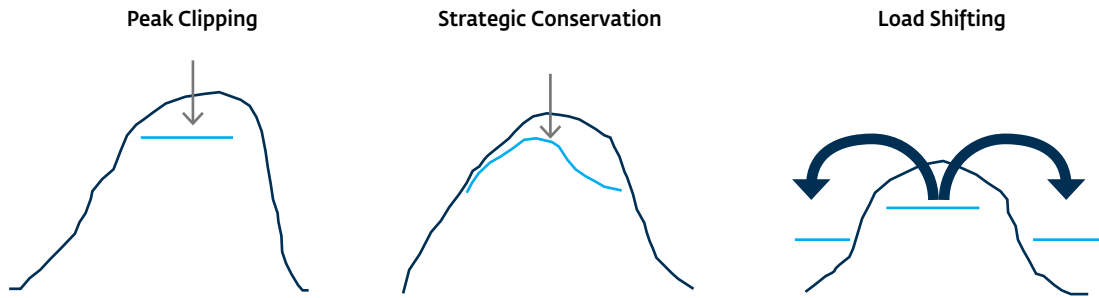

The example below shows logging at a facility with a high base load requirement (refrigeration). Based on live historical electrical readings, a pattern in the occurrence of peak demand was noted. The peak demand seemed to occur between 11:30am and 12:30pm. On two occasions, the spike in demand accounted for more than 50 kVA. This coincided with the canteen preparing for lunch. The 50 kVA cost the company more than R14 000/month and could easily be averted by employing load clipping/shifting strategies.

FIGURE 20: LIVE LOGGING PROFILE OF A PLANT WITH A HIGH REFRIGERATION LOAD

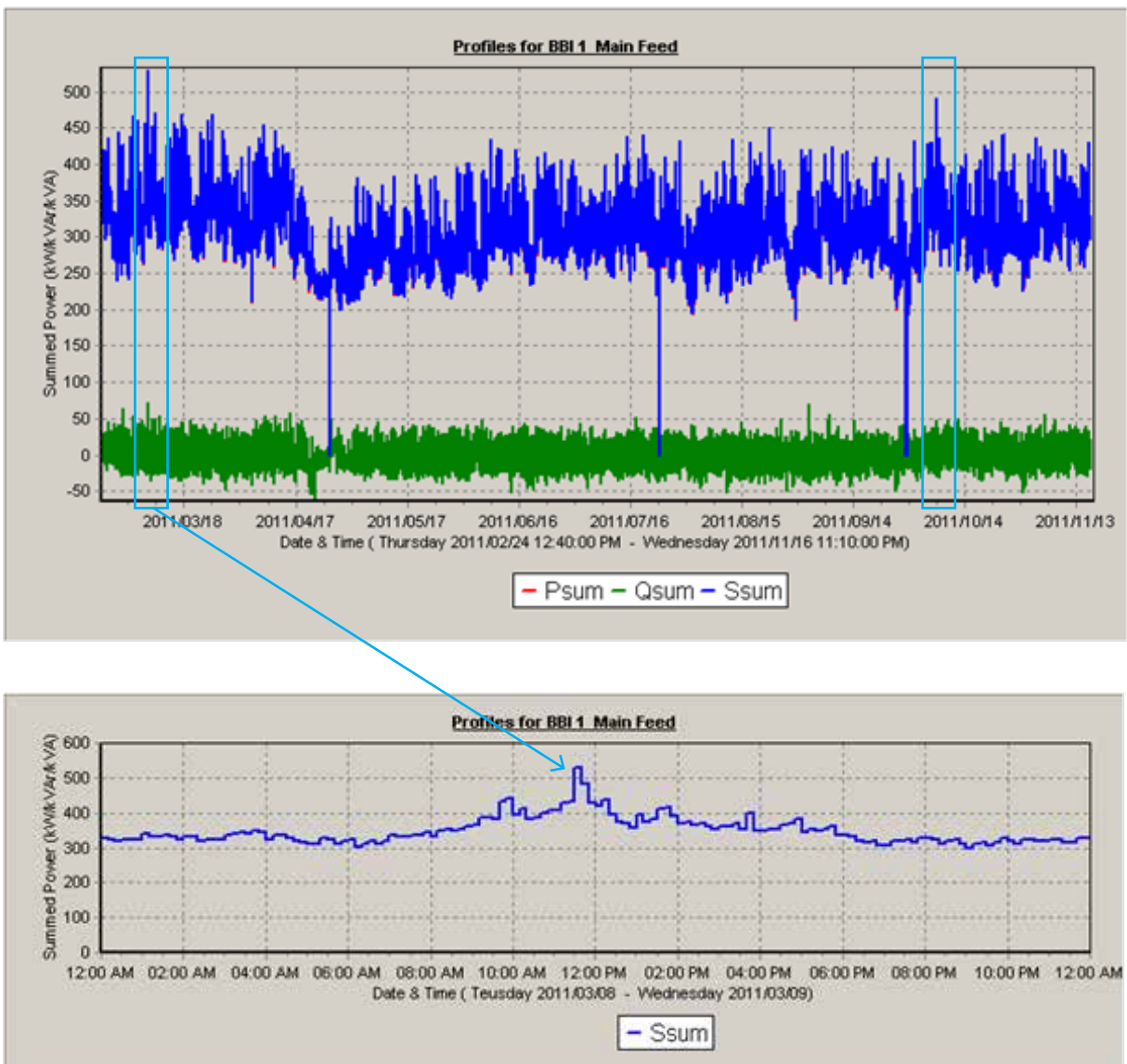

Live logging will reveal when the peak demand is incurred, and strategies could be employed to reduce or shift this demand.

Potential Issues/Problems

Care should be taken to avoid implementing timed shutdown events that would disrupt the process.

Indicative Cost-benefit Analysis

An aggressive peak demand management programme could see a 10% reduction in a facility's costs.

RECOMMENDED ACTION

1. Install live logging on the main feed.
2. Implement a demand management programme.

Pump System Optimisation

Observation

Pump systems frequently operate against unnecessary head pressure introduced either by system components (dynamic head) or by elevating the liquid to unnecessary height (static head). Unnecessary increases in head pressure result in a loss in efficiency, as the pump is pushed back on its curve away from its operating point, resulting in lower flow rates. Figure 22 illustrates the impact of increased head pressure through the installation of a tight bend or throttle valve.

FIGURE 21: PUMP SYSTEM CURVE ILLUSTRATING THE IMPACT OF THROTTLING⁹

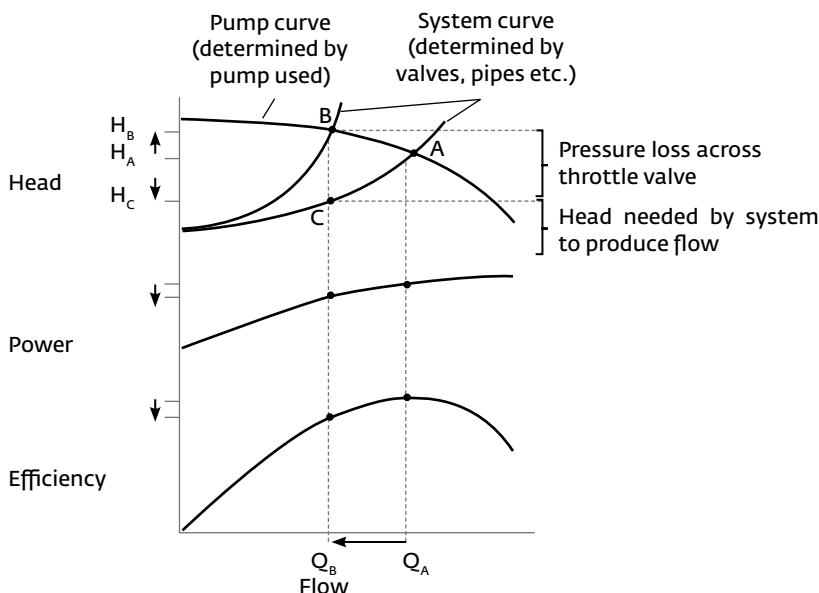

This loss can be avoided by installing pumps that are correctly sized or by fitting variable speed drives (VSDs). Figure 23 provides an indication of the impact of reducing the size of the pump.

⁹ ETSU, 1998

FIGURE 22: WASTE ENERGY AND POTENTIAL SAVINGS ILLUSTRATED BY REMOVING UNNECESSARY HEAD PRESSURE AND LINE THROTTLING

1. FLOW RATE AND PRESSURE CONTROL WITH VALVE THROTTLING

2. OPTION WITH SMALLER AND SLOWED DOWN PUMP

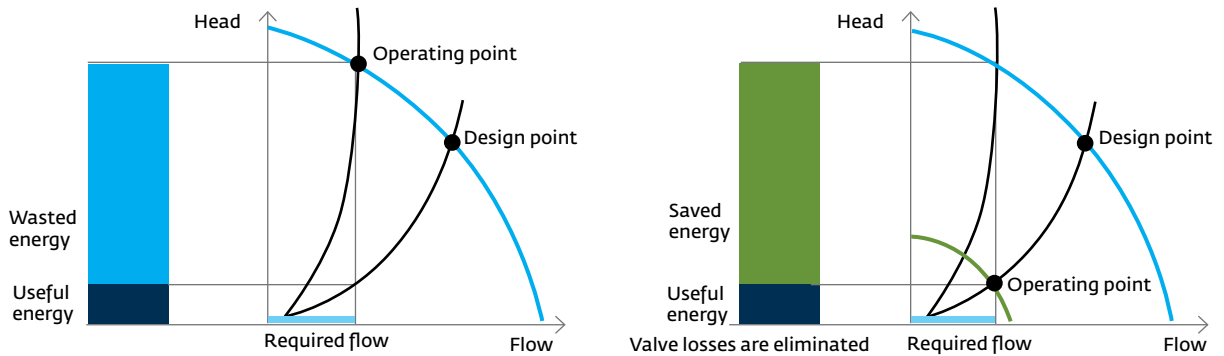

RECOMMENDED ACTION

1. Install decentralised tanks close to the borehole and then use booster pumps to feed to the plant.
2. Install level controls to shut off the feed pumps if the tanks are full.
3. Install above-ground piping to ensure that inspections can be done regularly.
4. Install timers on the pumps to turn off during peak electrical tariff periods.

Companies sometimes operate two pumps on a system designed for one to boost pressure and flow, or just to reduce pipework. Figure 24 indicates the impact of this type of strategy. While there is a marginal increase in pressure and flow, it results in an increased cost per kl pumped (usually around 30-40% higher) with reduced overall flow rate compared to the scenario where the pumps operate on their own system.

FIGURE 23: THE IMPACT OF RUNNING TWO PUMPS ON A SYSTEM DESIGNED FOR ONE

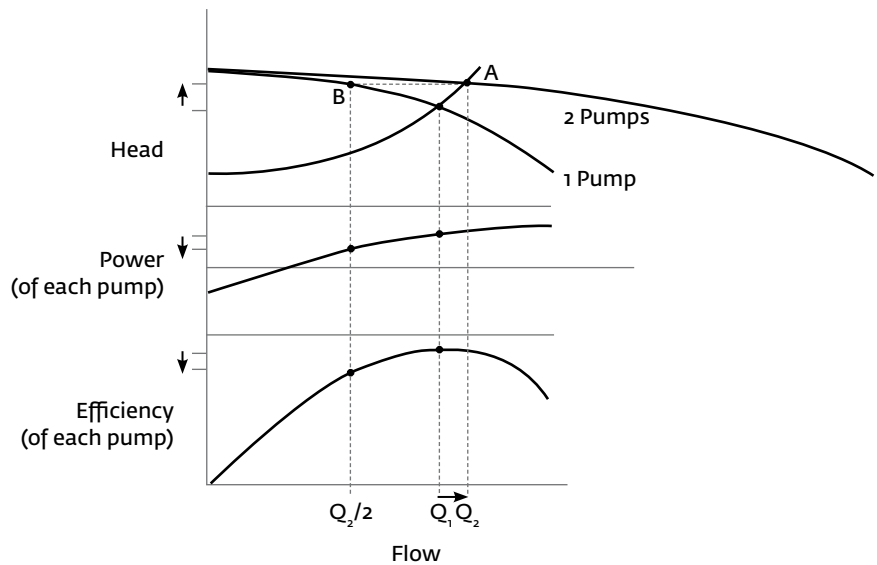

Rural abattoirs are heavily dependent on ground water reserves and may not have sufficient yield on existing boreholes to supply the plant demand. Existing boreholes typically range between 50-100 m deep and then need to elevate further to the storage tanks. If multiple borehole pumps are installed, they would invariably feed into a common line before feeding into the storage tank. Additional head is introduced through this configuration, resulting in significantly reduced flow rates. From the pump curve shown in Figure 25, the additional head introduced by lifting the water an additional 20 m would result in a 20-60% reduction in flow rate, depending on the borehole depth.

FIGURE 24: PUMP CURVE OF BOREHOLE PUMPS¹⁰

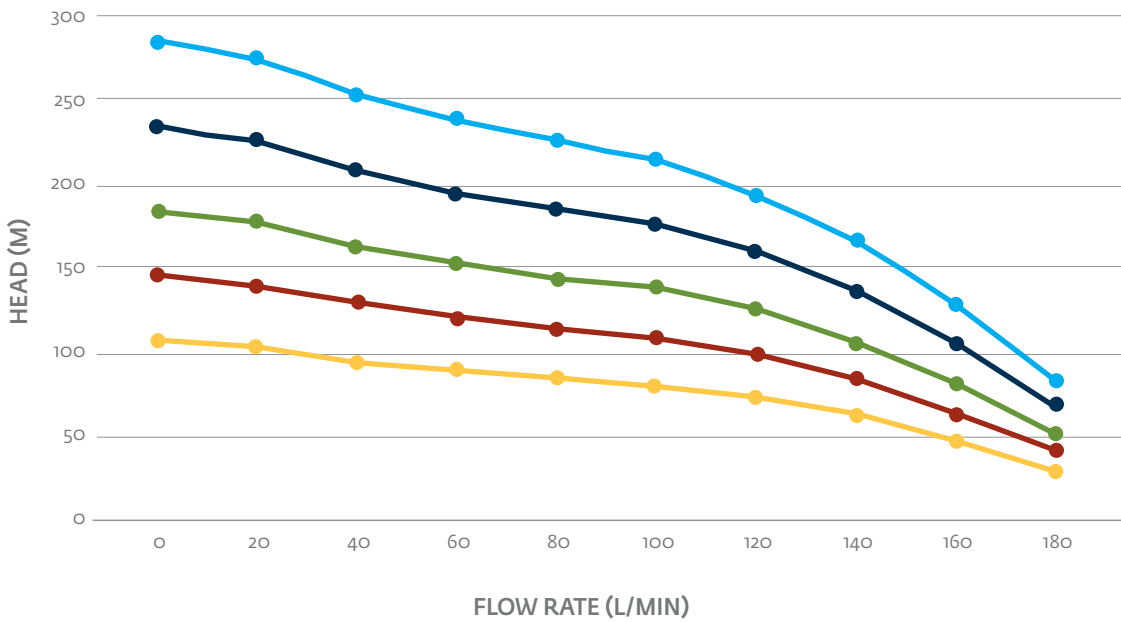

Potential Issues/Problems

Additional booster pumps will result in increased maintenance requirements.

Chiller System COP Management and Optimisation

Observation

Conventional decentralised freon-based chiller systems are used at many abattoirs, with many of the compressors operating at low loads. Considerable scope for optimisation exists through monitoring and managing the overall plant performance.

The refrigeration plants typically contribute to 45-50% of a plant’s electrical energy consumption and costs. Monitoring individual chiller COP and energy load profiles is essential to understanding the plant demand requirements and the system’s ability to cost-effectively meet the demand.

All cooling systems realise low levels of leakage of the refrigerant. If the refrigerant levels are not topped up timeously, the system will be more inefficient and the potential for breakdowns and lost production will increase. Figure 26 displays the effects of diminishing refrigerant levels in a chiller system¹¹.

¹⁰ Hurricane Pumps, 2020

¹¹ Energy Technology Support Unit, Didcot, UK (1997)

FIGURE 25: ILLUSTRATIONS OF THE EFFECT OF REFRIGERANT LEAKS

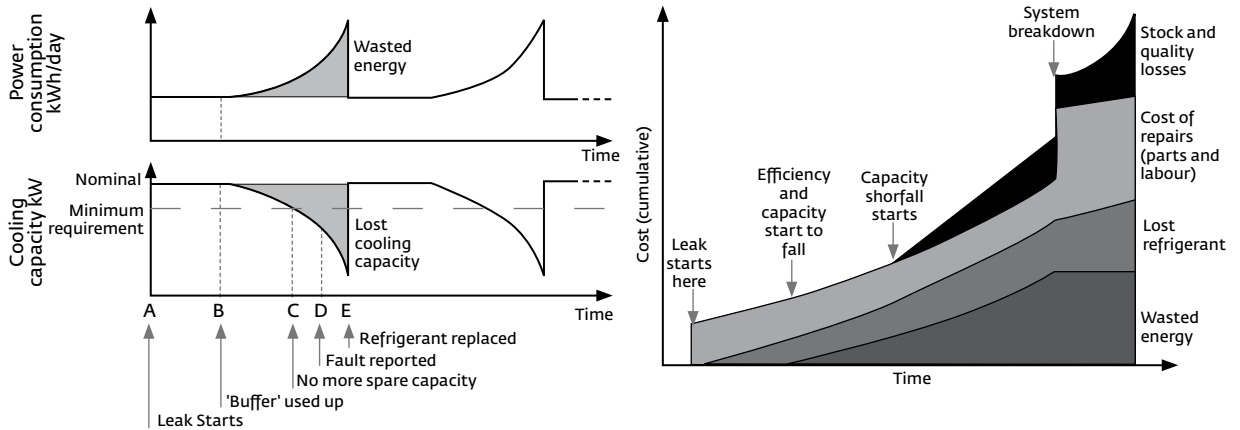

Trending chiller COP will predict system issues (e.g. low refrigerant levels) and allow for predictive maintenance. Optimal load strategies can only be determined if the demand of the plant is known. Figure 27 provides an indication of the types of load matching strategies.

FIGURE 26: LOAD MATCHING STRATEGIES FOR AIR AND COOLING COMPRESSORS¹²

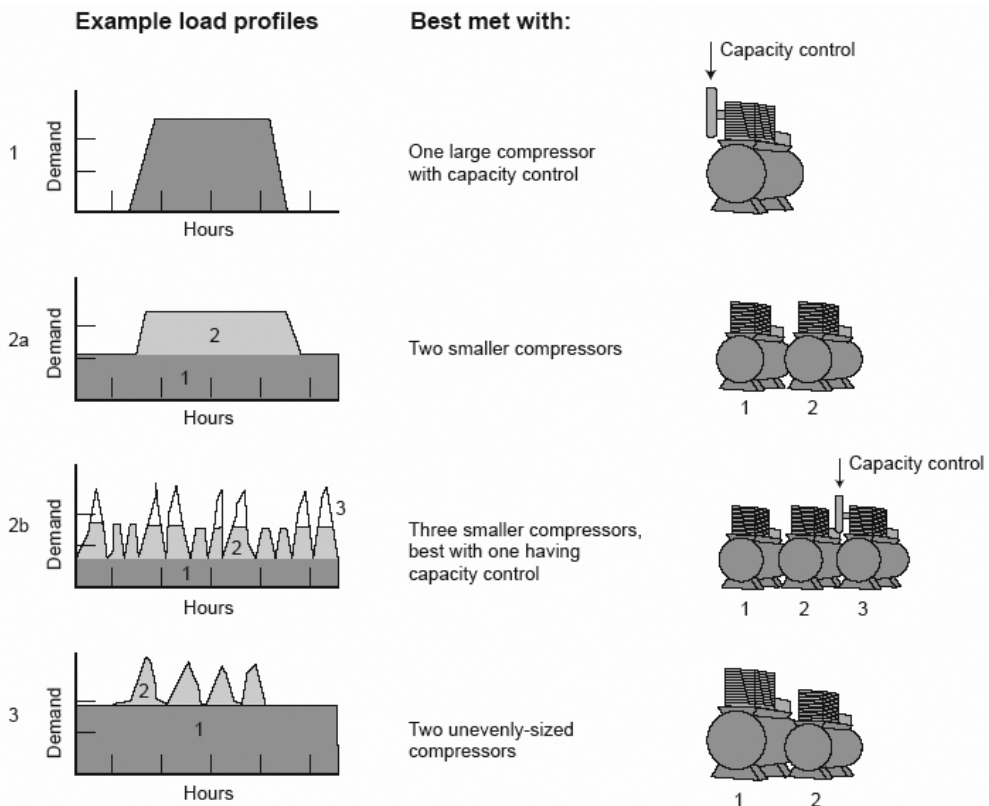

¹² Energy Technology Support Unit, Didcot, UK (2000)

Potential Issues/Problems

Additional information without clear lines of responsibility or automatic interpretation of the data will not realise savings. Investment in appropriate data management tools is required.

Indicative Cost-benefit Analysis

A 20-30% reduction in energy consumption on the compressors can be expected through actively monitoring the chiller COP and selecting the most efficient compressors for baseload operation.

Compressed Air System Optimisation

Observation

Compressed air accounts for roughly 10% of an abattoir's electrical energy consumption and the overall efficiency of the system is less than 15% once heat loss and line leaks are taken into account.

Compressor efficiencies vary with regard to their individual components and the load factor on the compressors. This can be seen in Figure 28; while a VSD will result in savings for a varying load pattern, these savings diminish if compressors are operated consistently at full or low load.

RECOMMENDED ACTION

1. Install dedicated electrical energy logging equipment to monitor plant loads.
2. Install flow meters and temperature sensors to determine individual chiller COP.
3. Operate the most efficient chillers as base load.
4. Trend COPs to pre-empt maintenance cycles (e.g. refrigerant leaks).
5. Measure overall system COP and set objectives and targets to increase overall COP.
6. Implement a leak detection program to ensure optimal refrigerant levels are maintained.
7. Turn off or slow down radiator fans when areas are not in use.

FIGURE 27: TYPICAL DEMAND ON COMPRESSORS WITH REDUCED PLANT LOAD¹³

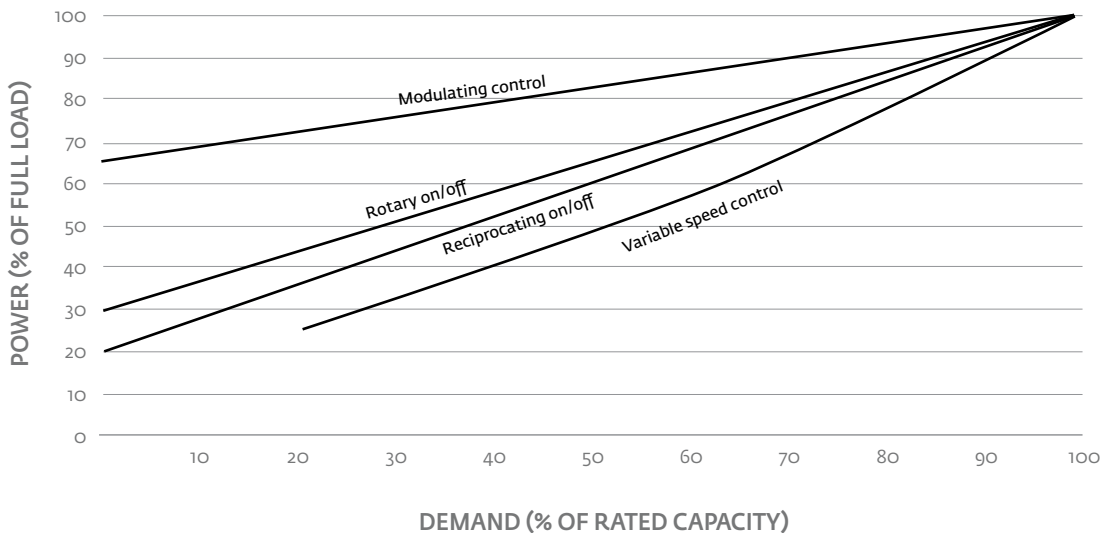

It is important when using load/unload control mechanisms to keep the number of cycles to a minimum, as there is energy lost between the unload point and the load point. In addition to power being drawn with no productive air being produced, there is a space between the unload point and the steady state where the motor draws close to the full rated power. This is illustrated by the area highlighted in red in Figure 29.

¹³ Energy Research Institute, 2000

FIGURE 28: ILLUSTRATION OF EFFICIENCY LOSS DURING UNLOAD CYCLE

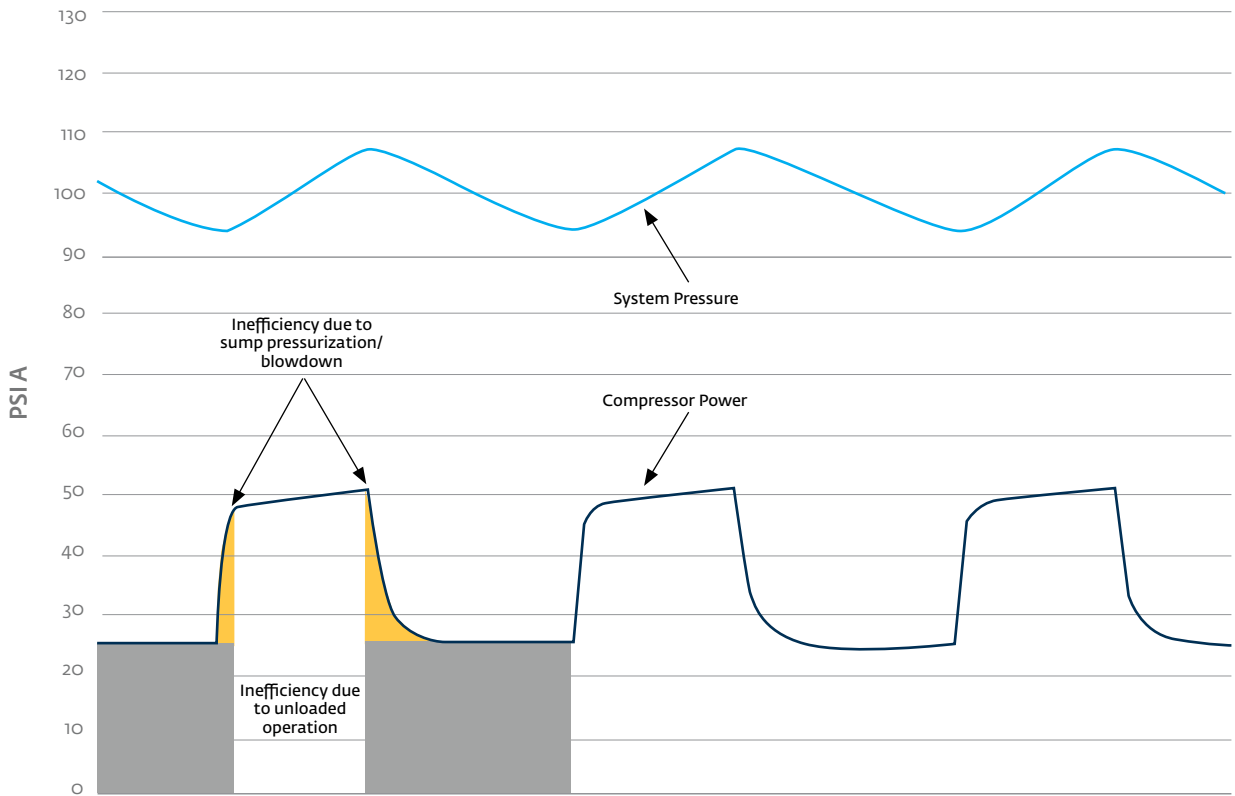

Even with optimal control strategies, over 78% of the input energy into air compressors is lost to waste heat. Most of this heat (~94%) can be recovered to pre-heat air or to heat water.

FIGURE 29: OVERVIEW OF HEAT RECOVERY POTENTIAL AND APPLICATIONS¹⁴

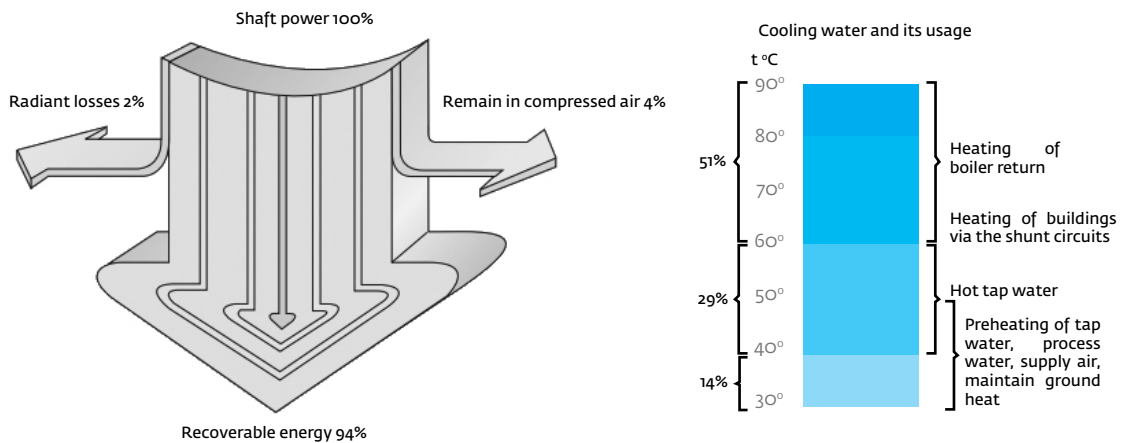

Significant losses are also incurred through distribution line leakage. Most facilities that actively monitor their leakage will target a leakage rate of 10% of system capacity. Facilities that do not actively manage their leakage will typically experience leakage rates as high as 20-30% of system capacity.

¹⁴ Atlas Copco Airpower, 2010

FIGURE 30: OVERVIEW OF INTERVENTIONS FOR COMPRESSED AIR SYSTEMS¹⁵

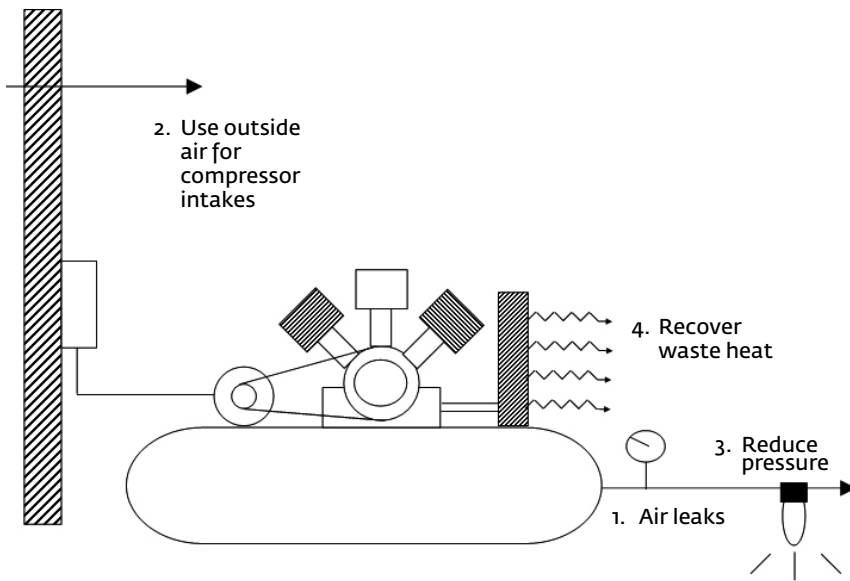

RECOMMENDED ACTION

In addition to optimising the load controls, Figure 31 provides some common savings interventions, which include:

1. Reduce compressed air leaks
2. Utilise cooler outside air
3. Reduce system pressure
4. Utilise waste heat productively.

BOX 2:

BEST PRACTICE FOR WASTE HEAT RECOVERY ON COMPRESSORS

Some companies in the food sector have installed economisers on their air compressors to recover low-grade heat. This type of intervention will realise an overall system efficiency of 50% as opposed to 15% typically experienced in compressed air facilities.

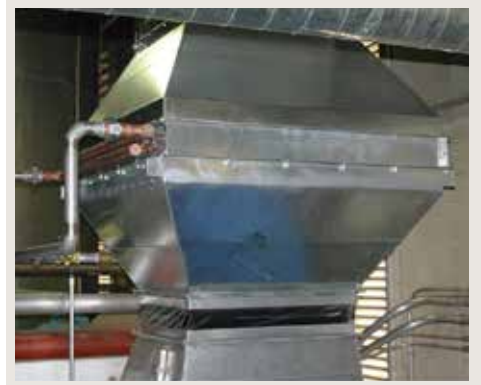

Indicative Cost-benefit Analysis

The following rules of thumb apply to compressed air systems:

- Optimising compressor controls can save 5-10% of the energy utilised by the compressed air system by more closely matching the load requirement.
- Reducing air compressor pressure by 2 psi can reduce compressor energy use by 1% (at 100 psi)¹⁶
- There will be a 1% reduction in compressor electrical energy utilisation for every 2.2°C reduction in intake gas¹⁷

Solar PV

Observation

Abattoirs' electrical energy costs range between R1.20/kWh and R1.60/kWh (including demand costs), depending on the tariff regime assigned to the abattoir. Solar companies are currently offering solar PV power purchase agreements at rates below R1.10/kWh, and the levelised cost of energy for a system owned by the abattoir will likely be cheaper. On a utility scale, the life-cycle cost of renewables are significantly more effective than that of conventional coal-based systems (see Figure 33).

¹⁵ Energy Research Institute, 2000

¹⁶ Oregon State University, 1997

¹⁷ Council for Scientific and Industrial Research, 2017

FIGURE 31: NEW BUILD LIFE CYCLE COST ON DIFFERENT POWER SOURCES (2016 RATES)¹⁸

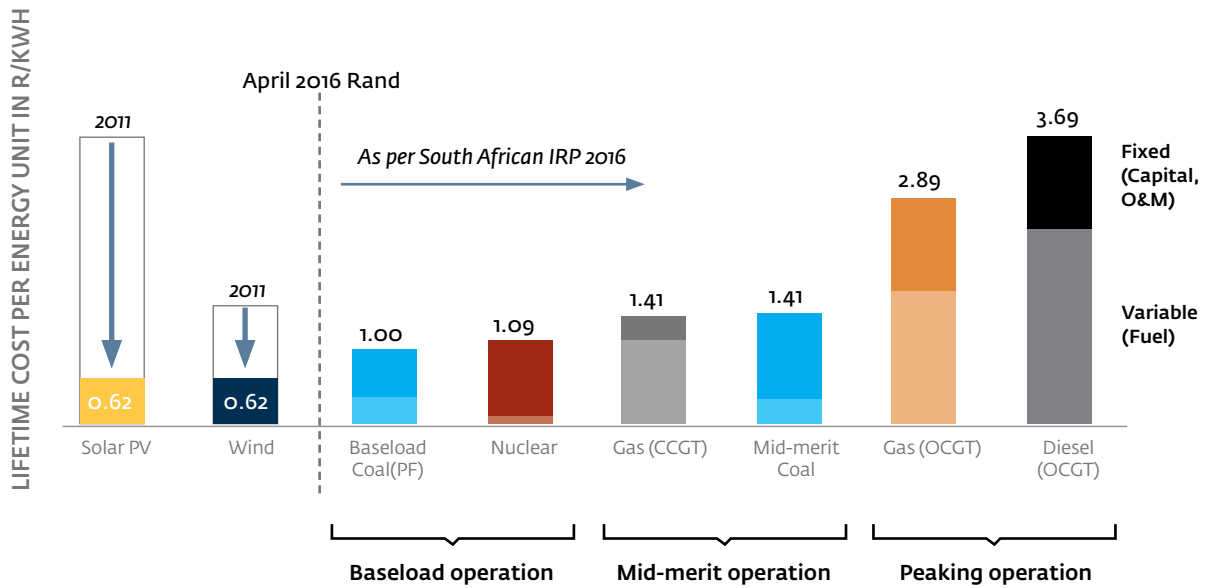

RECOMMENDED ACTION

Review solar PV as a potential energy source.

Abattoirs have fairly constant energy demand as a result of their high refrigeration and chilling requirements, which make the industry an excellent prospect for solar PV systems.

Potential Issues/Problems

Power purchase agreements may be enticing, but care should be taken to properly interrogate the proposed annual cost escalations (if any).

Indicative Cost-benefit Analysis

There would typically be a four- to five-year payback on solar PV installations. Financing is also more easily attained for these systems than general business financing.

¹⁸ Council for Scientific and Industrial Research, 2017

Thermal Energy

Larger plants with on-site rendering typically have steam systems utilising coal boilers. The fuel purchase cost of coal equates to roughly R0.30/kWh at the point of use. The operating and maintenance costs of these systems will add an additional R0.30-R0.50/kWh to the cost. Smaller abattoirs without rendering capability use either electrical heating elements or small liquid fuel-driven steam systems (flash steam generators) and their point-of-use cost will be in the vicinity of R1.10-R1.50/kWh. Their operating and maintenance costs (~R0.10/kWh) will be significantly lower than that of coal systems. It is important to note that while the fuel cost per kWh is relatively high on the smaller plants, their system efficiencies are significantly better, especially for point-of-use heating applications (heating elements at the sterilisers). Steam systems' overall thermal efficiencies for supplying heated water range between 40-75%, whereas electrical heating systems at the point of use exceed 95%. There is significant scope for improving costs and efficiencies in thermal heating systems, especially on smaller plants that have relatively high heating costs per kWh.

A typical abattoir could reduce its thermal energy consumed by an estimated 32% by implementing a number of thermal energy efficiency measures. Figure 34 provides an indication of the expected savings in the respective areas.

FIGURE 32: THERMAL ENERGY SAVINGS POTENTIAL FOR A TYPICAL ABATTOIR

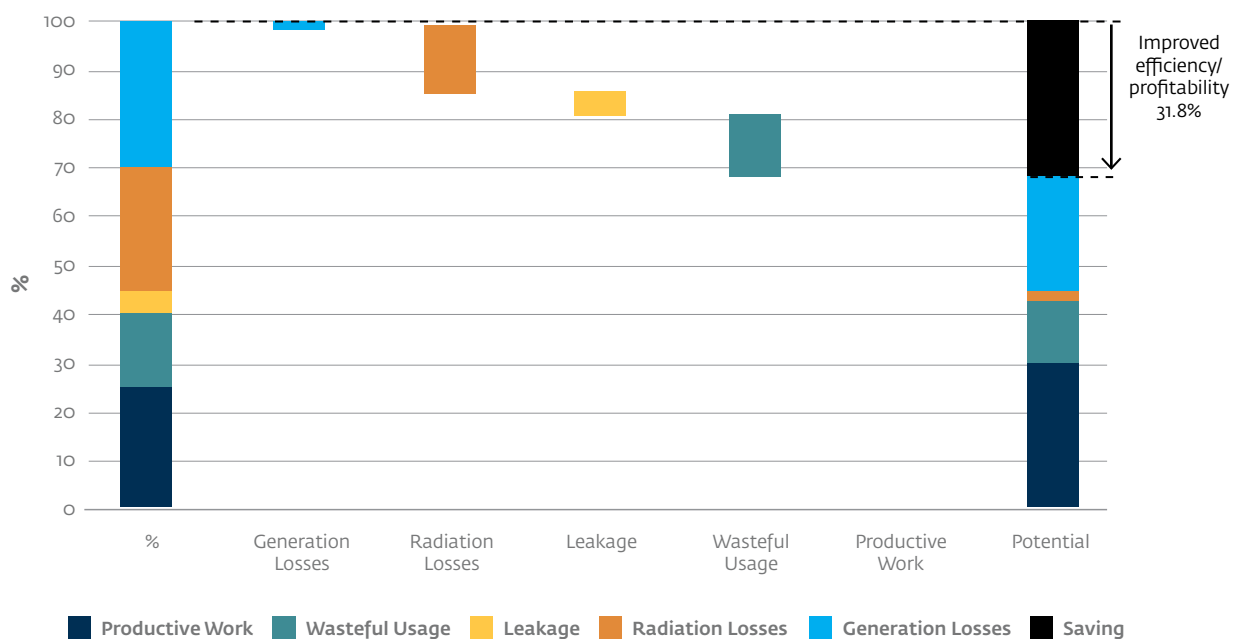

The following sections focus on these thermal energy minimisation opportunities.

Renewables and waste heat recovery

Observation

Implementing renewable and heat recovery systems on the rendering plant, the compressed systems and refrigeration systems could reduce the need for thermal heating for the hot water systems entirely in facilities with rendering plants, and by over 40% in facilities without rendering plants. Heat pumps can also significantly reduce the cost of heating water up to 50°C.

The heat load could be met with:

1. Refrigeration plant: ~10% of refrigeration plant load
2. Compressed air system: ~65% of air compressor load
3. Rendering plant heat recovery system
4. Solar hot water system/heat pumps.

Heat Pumps

Heat pumps are far more efficient than conventional electrical resistance heating applications within the optimal temperature bands (45-55°C). Typically, at ambient temperatures of around 20-25°C, a heat pump will produce 3-4 kW thermal energy for every 1 kW of electrical energy input (see Figure 35).

Electric heating requires around 1 kW to produce approximately 1 kW thermal energy. The heat pump effectively produces cool air or water as a "waste product", which can be used beneficially in the process (see Figure 35)¹⁹.

FIGURE 33: VAPOUR COMPRESSION CYCLE OF A HEAT PUMP

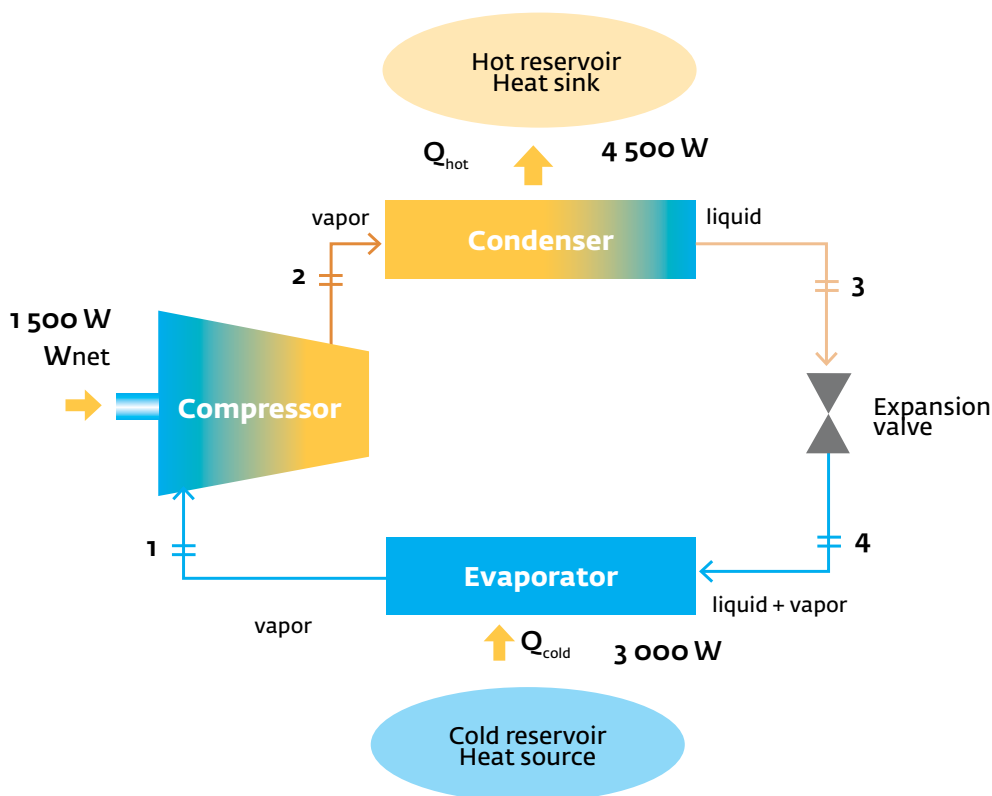

¹⁹ Nuclear Power, 2020

Applications able to utilise the “cool” output from the heat pump include:

- Fresh air intake into the plant
- Compressed air intake.

Refrigeration systems generate “cold air” and reject the heat from the system through condensers. It is possible to safely recover around 10% of this heat through a heat recovery system and a control valve on the hot flue gas as depicted in Figure 36.

FIGURE 34: ILLUSTRATION OF HEAT RECOVERY ON A REFRIGERATION SYSTEM ²⁰

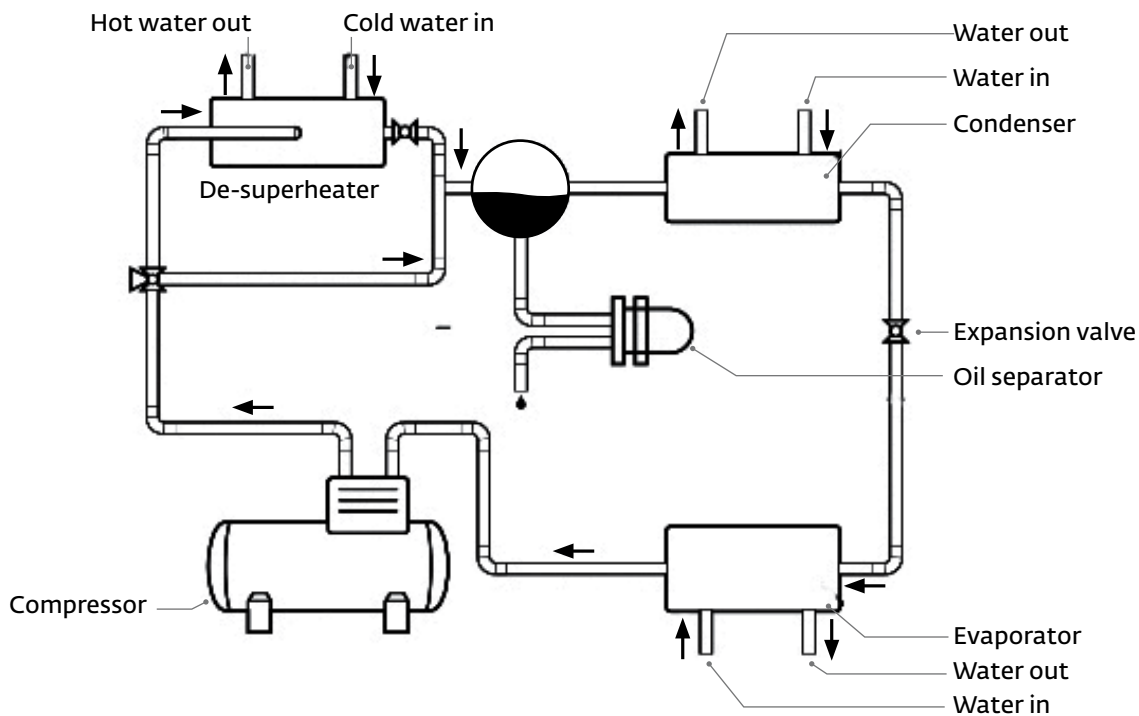

The recovered heat could be used for hand and boot washing or as a make-up for the 45°C, 65°C and 82°C lines.

Solar

South Africa boasts some of the best solar intensities in the world. This is illustrated by Figure 38 which illustrates the “direct normal irradiation” (DNI) levels.

BOX 3:

BEST PRACTICE FOR HEAT RECOVERY ON REFRIGERATION UNITS

Some abattoirs have already installed heat recovery refrigeration units or systems like the units depicted below, where the heat from condensing is recovered by a water loop which can then be used for heating, thereby resulting in improved efficiencies.



²⁰ Carbon Trust, 2020

RECOMMENDED ACTION

1. Investigate the option of installing a de-superheater system on the chillers.
 2. Install compressed air heat recovery system.
 3. Investigate installing heat recovery on the rendering plant.
 4. Investigate installing solar heating panels.
-

FIGURE 35: SOLAR IRRADIATION MAP²¹

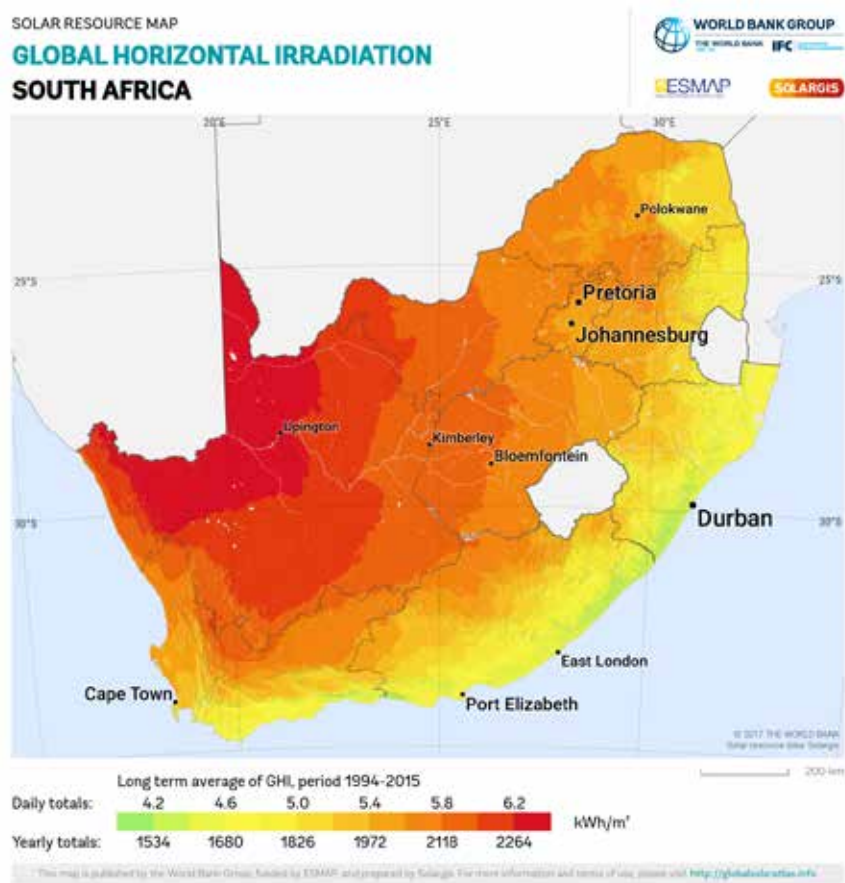

Solar heating is therefore a logical choice, especially for applications that draw warm water during the day (e.g. hand washing and other warm water applications).

Potential Issues/Problems

Detailed engineering would be required to implement these systems, which may prove to be cost prohibitive. Care should be taken to utilise softened water in the heating systems to prevent scale and corrosion on the hot water lines and tanks.

Indicative Cost-benefit Analysis

There will typically be a one- to two-year payback on heat recovery installations.

²¹ World Bank Group, 2020

BOX 4:

COMBINED HEAT AND POWER BIOGAS PLANT

Biogas plants basically rely on the anaerobic digestion of wastewater. During this process, methane is produced, and this could be captured for use in various applications such as pre-heating of process water, generation of electricity, etc.

The technology has not been widely adopted by the red meat abattoir industry, and various pitfalls may occur along the way. Certain elements, such as the uncontrolled release of large volumes of blood, chlorine and biocides used for cleaning purposes could have a disastrous effect on the biomass population required for methane gas production. Advanced technology is available for biogas plants in the red meat abattoir industry, but effective operation of the facility will be crucial.

A 75 kW combined heat and power (CHP) biogas plant has been successfully installed at a pig abattoir which uses pig manure as the feedstock from the adjacent piggery. The plant produces 834 MWh electrical and 1 075 MWh thermal energy per year, and there are plans to increase the capacity to 125 kW.



Optimise Steam System Generation Efficiency

Observation

Most boiler systems have no live load monitoring in place and would typically operate on very low loads at some point during the day. The boiler loss in efficiency in low load conditions is illustrated in Figure 40 and Table 2. Lower efficiencies as a result of ignition losses and cooling through the “chimney effect” when the boilers are not in fire mode can be expected.

FIGURE 36: TYPICAL BOILER EFFICIENCY CURVE

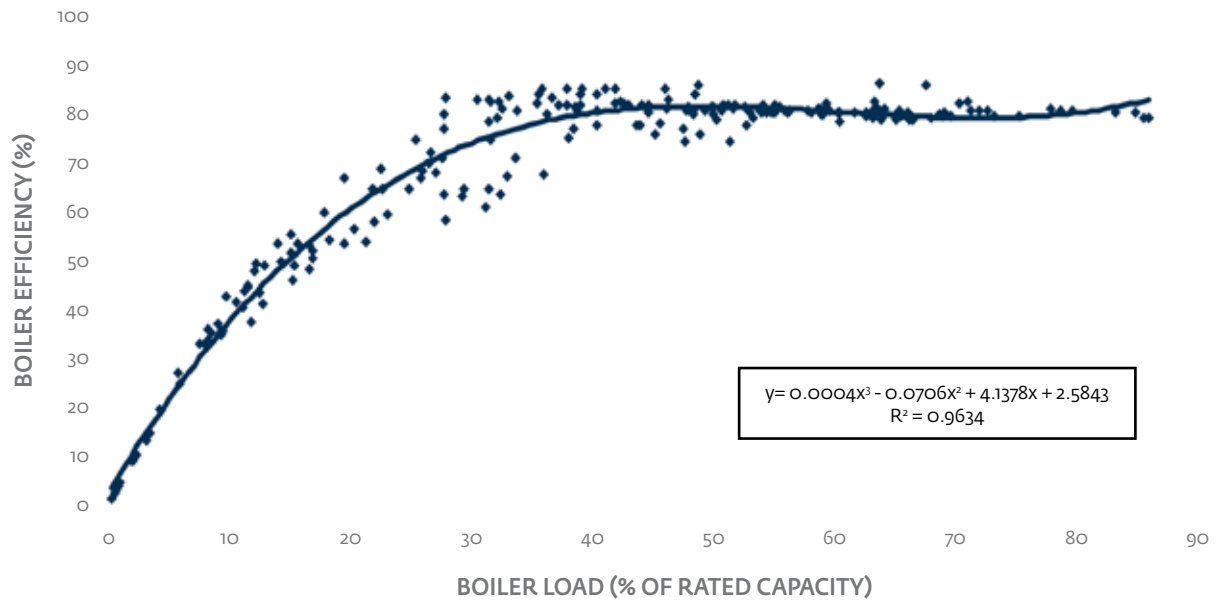

The overall system efficiency, once distribution losses are taken into account, can be calculated – an example is provided in Table 2. In this instance, radiation and condensate losses result in an overall system efficiency of 47%.

TABLE 2: OVERALL STEAM SYSTEM EFFICIENCY

AREA	THEORETICAL TARGET	BOILER
Boiler Losses		
Radiation loss/boiler design*	0.5%	1.0%
Flue gas loss	15.0%	14.8%
Unaccounted-for loss	1.0%	8.3%
Bleed*	0.5%	0.4%
Generation efficiency	83.0%	75.5%
Distribution Losses		
Radiation loss	1.0%	29.4%
Leakage	0.1%	1.2%
Condensate return loss	0.0%	5.2%
Flash steam loss	1.0%	1.8%
Subtotal	3.1%	37.6%
Overall Thermal Efficiency	80.4%	47.1%
KPIs		
Generation cost / tonne steam	162.46	172.19
Distribution cost / tonne steam	5.20	103.81
Point of use cost / tonne steam	167.66	276.00
Tonne steam / tonne fuel	8.3	7.8

Combustion systems require sufficient air to ensure that there is excess oxygen available for complete combustion. A lack of oxygen will result in incomplete combustion of the burner fuel which will in turn result in significant safety risks due to the potentially explosive nature of the flue gas that contains volatile hydrocarbons still capable of combusting. To this extent, burners are set to ensure excess air (which can be measured by the percentage of oxygen in the stack). Stack temperatures of around 200°C with oxygen levels of between 4-6% are typical. Supplying too much air, however, would result in unnecessary heat loss to the stack, as there would be an inadvertent cooling of the boiler. This condition can be identified through elevated oxygen content and lower stack temperatures (see the measurements below). Fouled heat exchange surfaces (i.e. fire side fouling) would result in elevated stack temperatures as a result of poor heat exchange, even if the oxygen set points were in the optimal range.

The steam generation and distribution losses can be calculated utilising first principles and a mass balance approach. The amount of steam produced can be indirectly calculated through estimating the amount of water discharged to blow-down (utilising the total dissolved solids [TDS] to calculate cycles of concentration). The steam energy content and the fuel energy content is known which with the volumes allows one to calculate the generation efficiency. Typically, generation efficiencies should be in the vicinity of 80% once the various losses have been taken into account.

An example of a typical plant's generation efficiency and associated losses is provided in Figure 40.

IN SUMMARY, THE BOILER SYSTEM'S GENERATION EFFICIENCY CAN BE DETERMINED THROUGH MONITORING THE FOLLOWING:

- Feed water temperature and metering
- Make-up water metering
- Boiler feed and blow-down TDS.

FIGURE 37: ANTICIPATED GENERATION EFFICIENCY OF THE BOILER

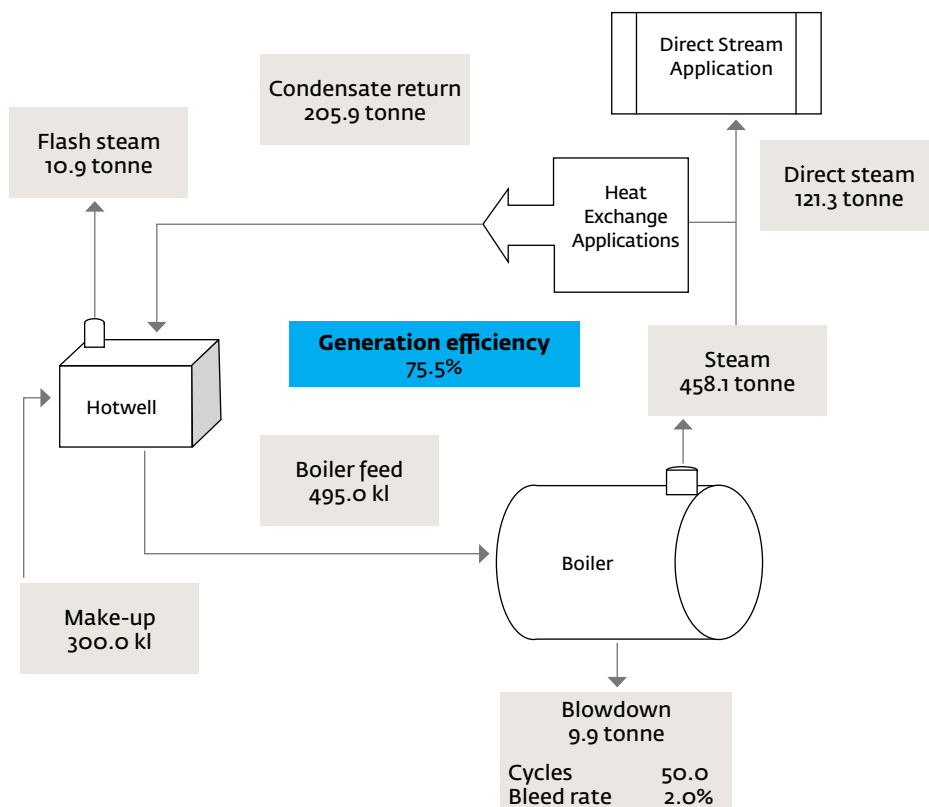

RECOMMENDED ACTION

1. Use the mass balance method for determining efficiency in addition to flue gas analyses.
 2. Install live loggers on the water feed.
 3. Calculate the overall system efficiency and set appropriate KPIs for staff.
 4. Reduce oxygen setpoints to between 4-6%.
-

Indicative Cost-benefit Analysis

A 2.5-5% improvement in generation efficiency through improved operating practices could be realised by focusing on improving generation efficiencies.

Insulate Steam Lines, Valves and Flanges

Observation

The total amount of uninsulated piping and components can be determined for the steam lines as well as the uninsulated condensate lines and the radiation loss can result in 10-30% losses in steam energy generated. Uninsulated lines, valves and flanges will experience radiation losses which can be quantified by determining the process / surface temperatures, the type of metal and the external temperatures.

FIGURE 38: RADIATION LOSS PICTURES ON STEAM LINES



RECOMMENDED ACTION

1. Insulate all exposed piping and install jacket covers on flanges and valves.
 2. Insulate the bodies of the expansion joints.
 3. Insulate condensate return piping.
 4. Insulate condensate return tank
-

Potential Issues/Problems

Insulation can often hide leaks or inhibit maintenance. Insulation installed should take into account the requirement to service components.

BOX 5:**BEST PRACTICE FOR STEAM PIPING – INSULATION FOR VALVES AND FLANGES²²**

The pictures below provide an indication of insulation best practice, with flanges and valves insulated with removable steam jackets.

**Indicative Cost-benefit Analysis**

Table 3 outlines the losses experienced through poor insulation. An 80% reduction in radiation losses is viable through the installation of insulation. The table provides an indication of heat losses for different applications and how these can be calculated.

TABLE 3: RADIATION LOSS TABLE FOR STEAM LINES

UNINSULATED LINES (M)		LOSS W / M	TOTAL LOSS KW	STEAM TONNE / ANNUM	COST / ANNUM
50mm line (2")		500.0	0.0	0.0	R 0
75mm line (3")	5	650.0	3.3	22.0	R6 185
100mm line (4")	6	800.0	4.8	32.4	R9 134
150mm line (6")	7	1 200.0	8.4	56.8	R15 985
Uninsulated condensate / feed (m)					
50mm line (2")	100	230.0	23.0	155.4	R43 768
75mm line (3")		300.0	0.0	0.0	R0
Uninsulated items (0.5m per item)					
75mm line (3")	5	650.0	1.6	11.0	R3 092
100mm line (4")	5	800.0	2.0	13.5	R3 806
150mm line (6")	5	1 200.0	3.0	20.3	R5 709
Uninsulated Application					
Hot well	80	453.0	36.2	244.9	R87 679
Total			76	511	R162 000

²² Flextra Engineering Products (Pty) Ltd, 2020

RECOMMENDED ACTION

Implement an aggressive condensate return and condensate line insulation programme.

Condensate Recovery

Observation

A number of condensate leaks were noted during the site visits, as well as applications that utilised direct steam injection instead of heat exchangers. These would result in a 5% reduction in overall system efficiency.

Condensate is the ideal boiler feed water due to its heat content and chemical suitability. The higher the temperature of the boiler feed water, due to a high level in condensate return, the less work the boiler has to do in converting water into steam.

Potential Issues/Problems

Some of the condensate discharged to drain may not have enough pressure to be incorporated back into the condensate lines.

Indicative Cost-benefit Analysis

The indicative cost-benefit analysis is illustrated in Figure 43.

FIGURE 39: EXPECTED FUEL SAVING THROUGH INCREASED CONDENSATE RETURN²³

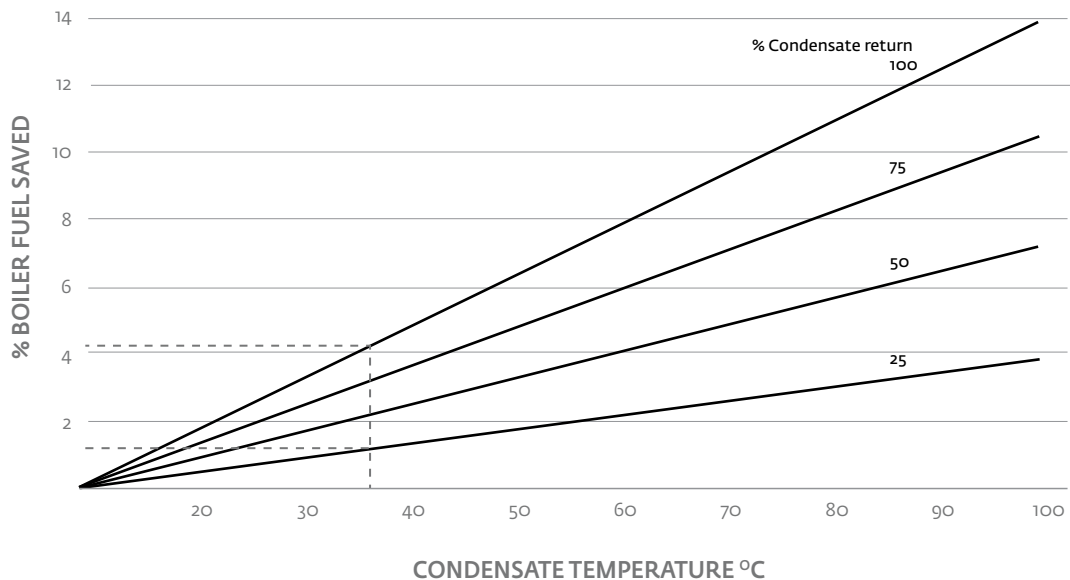

²³ Envirowise Best Practice Programme, 1999

Summary of Energy Efficiency Recommendations

The electrical and thermal energy consumption and cost can conservatively be reduced by between 12-32% through the implementation of the interventions described in the previous sections. A summary of all the energy saving recommendations is provided in the table below.

TABLE 4: SUMMARY OF ENERGY SAVING RECOMMENDATIONS

SECTION	RECOMMENDED ACTIONS	POTENTIAL SAVINGS
Electrical Energy		
Review electrical tariff	<ol style="list-style-type: none"> 1. Request a tariff review from the local authority or Eskom. 	Tariff changes can result in savings of between 10-20% of the cost of electricity.
Reduce peak electrical demand	<ol style="list-style-type: none"> 1. Install live logging on the main feed. 2. Implement a demand management program. 	An aggressive peak demand management program could see a 10% reduction in the facility's costs.
Pump system optimisation	<ol style="list-style-type: none"> 1. Install decentralised tanks close to the borehole and then use booster pumps to feed to the plant. 2. Install level controls to shut off the feed pumps if the tanks are full. 3. Install above-ground piping to ensure that inspections can be done regularly. 4. Install timers on the pumps to turn off during peak electrical tariff periods. 	n/a
Chiller system COP management and optimisation	<ol style="list-style-type: none"> 1. Install dedicated electrical energy logging equipment to monitor the plant loads. 2. Install flow meters and temperature sensors in order to determine individual chiller COP. 3. Operate the most efficient chillers as base load. 4. Trend COPs to pre-empt maintenance cycles (e.g. refrigerant leaks). 5. Measure overall system COP and set objectives and targets to increase overall COP. 6. Implement a leak detection program to ensure optimal refrigerant levels are maintained. 7. Turn off or slow down radiator fans when areas are not in use. 	A 20-30% reduction in energy consumption on the compressors could be expected through actively monitoring the chiller COP and selecting the most efficient compressors for baseload operation.
Compressed air system optimisation	<ol style="list-style-type: none"> 1. Reduce compressed air leaks. 2. Utilise cooler outside air. 3. Reduce system pressure. 4. Utilise waste heat productively. 	<p>Optimising compressor controls can save 5-10% of the energy utilised by the compressed air system by closely matching the load requirement.</p> <p>Reducing air compressor pressure by 2 psi can reduce compressor energy use by 1% (at 100 psi).</p> <p>There would be a 1% reduction in compressor electrical energy utilisation for every 2.2°C reduction in intake gas.</p>
Solar PV	<ol style="list-style-type: none"> 1. Review solar PV as a potential energy source. 	Typically there would be a 4-5-year payback on solar PV installations.

SECTION	RECOMMENDED ACTIONS	POTENTIAL SAVINGS
Thermal Energy		
Renewables and waste heat recovery	<ol style="list-style-type: none"> 1. Investigate the option of installing a de-superheater system on the chillers. 2. Install a compressed air heat recovery system. 3. Investigate installing heat recovery on the rendering plant. 4. Investigate installing solar heating panels. 	There would typically be a 1-2-year payback on heat recovery installations.
Optimise steam system generation efficiency	<ol style="list-style-type: none"> 1. Use the mass balance method for determining efficiency in addition to flue gas analyses. 2. Install live loggers on the water feed. 3. Calculate the overall system efficiency and set appropriate KPIs for staff. 4. Reduce oxygen setpoints to between 4-6%. 	A 2.5-5% improvement in generation efficiency through improved operating practices could be realised by focusing on improving generation efficiencies.
Insulate steam lines, valves and flanges	<ol style="list-style-type: none"> 1. Insulate all exposed piping and install jacket covers on flanges and valves. 2. Insulate the bodies of the expansion joints. 3. Insulate condensate return piping. 4. Insulate condensate return tank. 	An 80% reduction in radiation losses is viable through the installation of insulation.
Condensate recovery	<ol style="list-style-type: none"> 1. Implement an aggressive condensate return and condensate line insulation programme. 	2-4% of boiler fuel

Summary and Conclusions

The *Resource Efficiency Benchmarking Study* and the *Practical Guide for Improving Resource Efficiency in Red Meat Abattoirs in South Africa* have identified a number of energy and water efficiency opportunities and outline practical measures to improving resource efficiency. The red meat abattoir industry is a major water user in South Africa, utilising an estimated 4.5 million kl of water per year.

The Study found that a typical abattoir could reduce its water consumption by 27.5% by implementing a number of water efficiencies measures, a potential saving of up to 243l/SU in South Africa. Similarly, a typical abattoir could reduce its electrical energy consumption by an estimated 12% and thermal energy consumption by 32%. The industry is encouraged to adopt appropriate metering and monitoring practices to assist in identifying opportunities, track progress and enable continuous improvement.

The resource efficiency measures detailed in this report will assist South Africa to reduce the widening gap between water supply and demand, as well as alleviate pressures on the electrical supply grid and the country's natural resources.

References

- Atlas Copco Airpower. (2010). Compressed air manual. 7th edition.
- Carbon Trust. (2020). How to implement heat recovery in refrigeration. Retrieved 11 February 2020, from https://www.carbontrust.com/media/147189/j8o88_ctlo56_heat_recovery_in_refrigeration_aw.pdf.
- Christeyns. (2017). Hygiene through cavitation: ultrasonic cleaning in the food industry. Retrieved 10 February 2020, from <https://www.christeyns.com/en/news/hygiene-through-cavitation-ultrasonic-cleaning-food-industry>
- Council for Scientific and Industrial Research. (2017). The case for renewable energy to provide base load energy in South Africa.
- Energy Research Institute. (2000). How to save energy and money in compressed air systems.
- Energy Technology Support Unit (ETSU) 1998. Energy Savings in Industrial Water Pumping Systems on behalf of Envirowise (UK) Good Practice Guide 249 (no longer in print).
- Energy Technology Support Unit. (2000). Designing energy efficient refrigeration plants. Good Practice Guide 278.
- Envirowise Best Practice Programme. (1999). Energy efficient operation of industrial boiler plant. Good Practice Guide 30.
- Eskom. (2019). Schedule of standard prices for Eskom tariffs 1 April 2019 to 31 March 2020 for non-local authority supplies.
- Flextra Engineering Products (Pty) Ltd. Removable insulation jackets / covers. Retrieved 3 June 2020, from <https://www.flextra.co.za/products/removable-insulation/>.
- Hurricane Pumps. (2020). Retrieved 23 April 2020, from <http://hurricanepumps.co.za/>.
- International Finance Corporation. (2019). South African agri-processing resource efficiency: Opportunities, challenges and outlook.
- International Finance Corporation. (2020). Benchmarking study: Resource efficiency in red meat abattoirs in South Africa.
- Meat and Livestock Australia Ltd. (2002). Eco-efficiency manual for meat processing.
- National Cleaner Production Centre South Africa. (2019). Advanced steam training course.
- Nuclear Power. Retrieved 11 February 2020, from <https://www.nuclear-power.net/wp-content/uploads/2017/06/vapor-compression-cycle-heat-pump.png>
- Oregon State University. (1997). How to take a self-guided tour of your compressed air system.
- Red Meat Levy Admin. (2019). MSMS Data November 2018 to October 2019.
- Rutgers University. Office of Industrial Productivity & Energy Assessment. (1995). Modern industrial assessments: A training manual.
- World Bank Group. (2020). 2030 Water Resources Group
- World Bank Group. (2020). Global solar atlas. Retrieved from <https://globalsolaratlas.info>.
- World Wildlife Fund. (2016). Water facts & futures: Rethinking South Africa's water future

For More Information visit
www.ifc.org

IN PARTNERSHIP WITH

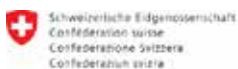

Schweizerische Eidgenossenschaft
Confédération suisse
Confederazione Svizzera
Confederaziun svizra

Federal Department of Economic Affairs FDFA
State Secretariat for Economic Affairs SECO



IFC

**International
Finance Corporation**
WORLD BANK GROUP

Creating Markets, Creating Opportunities